

BARCO

BARCO Projection Systems



90 00560

90 00569

OWNER'S MANUAL

for software release 2.x

Date :
27/03/92

Rev. :
01

ART. NR. :
59 75194

Due to constant research, the information in this manual is subject to change without notice.

Produced by BARCO NV, 1992
All rights reserved.

Printed in Belgium.

CONTENTS

Safety instructions	1
Location an functions of controls	9
Rear panel terminology	10
Front panel terminology	12
RCU800 control panel terminology	13
Controlling the projector with the RCU800	15
Power (mains) connection	17
Power (mains) cord connection	18
Switching on	19
Source connections	21
Signal input connections to a stand alone projector.	22
Connecting a Video source to input 1	23
Connecting a S-Video source to input 2	24
Connecting a RGB Analog source to the analog inputs of the projector.	25
Connecting a RGB TTL source to the RGB TTL input of the projector.	26
Connecting a RGB TTL (EGA) source to the projector.	27
Connecting an IBM PS/2 computer to the projector.	28
Projector control	29
Stand alone projector	30
The RCU800	30
Controlling stand alone projector with the RCU800.	31
Chained projectors	35
The RCU800	35
Controlling chained projectors	35
Installation adjustment mode	37
Access to optical controls	38
Entering the adjustment mode	39
Adjustment mode	40
Overview flow chart installation adjustment mode	43
Installation adjustment mode	44
Optical lens focusing	45
Raster centering	46
CRT projection angle adjustment	47
Left-right, top-bottom focusing	50
Guided adjustment mode	51
Start up of the guided adjustment mode	52
Overview flow chart 'Guided adjustment' procedure	53
Selecting Setup Pattern.....	55
Internal Cross Hatch Pattern.....	56
Raster centering on Green CRT Faceplate	58
Shifting Red and Blue on Green	59
Left-Right adjustments	60
Vertical Centerline Bow Adjustment	60
Vertical Centerline Skew Adjustment	61
Side Keystone Adjustment	62
Side Bow Adjustment	63
Horizontal Size Adjustment.....	64
Top-Bottom Adjustments	65
Horizontal Centerline Bow Adjustment.....	66
Top Keystone Adjustment.....	67
Top Bow Adjustment.....	68

CONTENTS

Bottom Keystone Adjustment	69
Bottom Bow Adjustment	70
Size-linearity Adjustment	71
Horizontal Size Adjustment	72
Vertical Linearity Adjustment	73
Vertical Size Adjustment	74
Horizontal Phase Adjustment	75
Convergence Adjustment	76
Blanking Adjustment	78
Top Blanking Adjustment	79
Bottom Blanking Adjustment	80
Left Blanking Adjustment	81
Right Blanking Adjustment	82
Random Access Adjustment Mode	83
Starting up the random access adjustment mode	84
Overview flow chart 'Random Access Adjustment' mode	85
Selecting Setup Pattern	88
Internal Cross Hatch Pattern	89
Random Access Adjustment Mode Selection Menu	90
Sync Fast/Slow Adjustment	90
Enhanced Blue On/Off Adjustment	91
Color Select	91
Color adjustments	92
White balance	93
Black balance	94
Geometry-Convergence Adjustments	95
Green Geometry Adjustments	96
Horizontal Phase Adjustment	97
Raster Shift Adjustment	98
Left-Right Adjustments	99
Vertical Centerline Bow Adjustment	100
Vertical Centerline Skew Adjustment	101
Side Keystone Adjustment	102
Side Bow Adjustment	103
Top-Bottom Adjustments	104
Horizontal Centerline Bow Adjustment	105
Top Keystone Adjustment	106
Top Bow Adjustment	107
Bottom Keystone Adjustment	108
Bottom Bow Adjustment	109
Horizontal Size Adjustment	110
Vertical Linearity Adjustment	111
Vertical Size Adjustment	112
Blanking Adjustments	113
Top Blanking Adjustment	114
Bottom Blanking Adjustment	115
Left Blanking Adjustment	116
Right Blanking Adjustment	117
Red or Blue on Green Geometry Adjustments	118
Red or Blue Raster Shift Adjustment	119
Top-Bottom Adjustments	120
Horizontal Centerline Bow Adjustment	121
Top Keystone Adjustment	122
Top Bow Adjustment	123
Bottom Keystone Adjustment	124
Bottom Bow Adjustment	125

CONTENTS

Red or Blue on Green Convergence Adjustments	126
Service mode	129
Starting up the service mode	130
Overview flow chart 'service' mode	131
Start up screen	133
Copy a block	134
Delete of blocks	135
Deleting block per block	135
Delete of all blocks	137
Change password	138
Run time	139
Set to midposition	140
Convergence off	140
Specification	141
Options	145
RCU800U	146
IR Receiver	147
Hardwired RCU800 or RCU800U	148
Control 800 software for DOS and for MAC	149
D9-D9 communication cable	150
Messages, warnings and failures	151
Appendix A : Battery replacement in the RCU	157
Appendix B : Adjustment blocks	158
Appendix C : Source numbers 90 - 99	159

CONTENTS

SAFETY INSTRUCTIONS

WARNINGS

SAFETY INSTRUCTIONS

ON SAFETY

ON INSTALLATION

ON SERVICING

ON CLEANING

ON REPACKING

ON ILLUMINATION

SAFETY INSTRUCTIONS

INSTALLATION INSTRUCTIONS

Before operating the set please read this manual thoroughly, and retain it for future reference.

Installation and preliminary adjustments should be performed by qualified BARCO personnel or BARCO authorised service dealers.

OWNER'S RECORD

The part number and serial number are located at the rear side of the projector. Record these numbers in the spaces provided below. Refer to them whenever you call upon your BARCO dealer regarding this product.

PART NUMBER: _____ **BARCO Projection Systems**

CH. ____ **SER. NUMBER** _____ **BELGIUM**

SAFETY INSTRUCTIONS

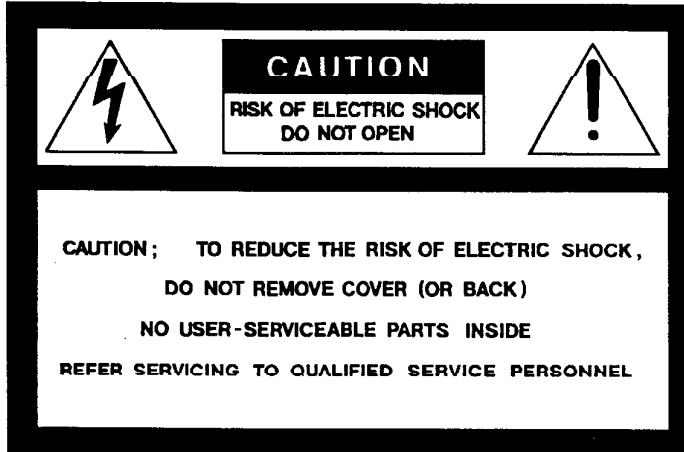

The lightning flash with an arrowhead within a triangle is intended to tell the user that parts inside this product are risk of electrical shock to persons.



The exclamation point within a triangle is intended to tell the user that important operating and/or servicing instructions are included in the technical documentation for this equipment.

WARNING
TO PREVENT FIRE OR ELECTRICAL SHOCK HAZARD, DO NOT EXPOSE THIS PROJECTOR TO RAIN OR MOISTURE

FEDERAL COMMUNICATION COMMISSION (FCC STATEMENT)

This equipment generates, uses, and can radiate radio frequency energy and if not installed and used in accordance with the instruction manual, may cause interference to radio communications. It has been tested and found to comply with the limits for Class A computing device pursuant to Subpart J of Part 15 of FCC Rules, which are designed to provide reasonable protection against such interference when operated in a commercial environment. Operation of this equipment in a residential area is likely to cause interference in which case the user at his own expense will be required to take whatever measures be required to correct the interference.

SAFETY INSTRUCTIONS

* All the safety and operating instructions should be read before using this unit.

* The safety and operating instructions manual should be retained for future reference.

* All warnings on the projector and in the documentation manuals should be adhered to.

* All instructions for operating and use of this equipment must be followed precisely.

ON SAFETY

1. This product should be operated from the type AC power source indicated on the marking label, visible through the clear window on the top cover of the projector.

Operating AC power voltage of the projector:

BARCOGRAPHICS 800

Art.Nr 90 00560 (220V AC)

Art.Nr.90 00569 (110V AC)

If you are not sure of the type of AC power available, consult your dealer or local power company.

2. This product is equipped with a 3-wire grounding plug, a plug having a third (grounding) pin. This plug will only fit into a grounding-type power outlet. This is a safety feature. If you are unable to insert the plug into the outlet, contact your electrician to replace your obsolete outlet. Do not defeat the purpose of the grounding-type plug.

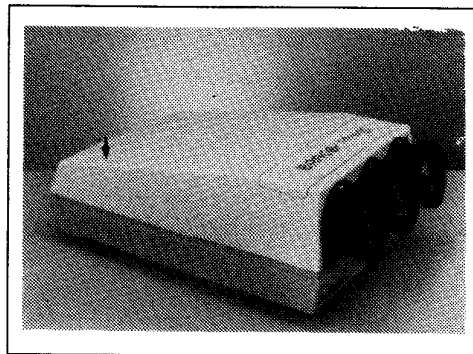

WARNING: THIS APPARATUS MUST BE GROUNDED (EARTHED)

WARNING FOR THE CUSTOMERS: THIS APPARATUS MUST BE GROUNDED (EARTHED) via the supplied 3 conductor AC power cable in accordance with the following instructions:

SAFETY INSTRUCTIONS

A. Mains lead (AC Power cord) with CEE 7 plug:

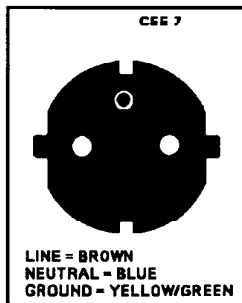

As the colors of the mains lead are colored in accordance with the following code:

Green-and-yellow:	Earth (safety earth)
Blue:	Neutral
Brown:	Live

As the colors of the wires in the mains lead of this projector may not correspond with the colored markings identifying the terminals in your plug, proceed as follows.

The green-and-yellow wire must be connected to the terminal in the plug which is marked with the letter E or by the safety earth symbol \perp or colored green or green-and-yellow.

The blue wire must be connected to the terminal which is marked with the letter N or colored black. The brown wire must be connected to the terminal which is marked with the letter L or colored red.

B. Power cord with ANSI 73.11 plug:

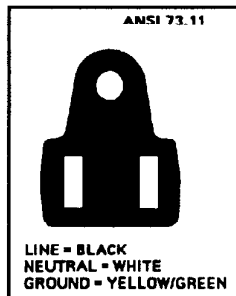

The wires of the power cord are colored in accordance with the following code.

Green/yellow:	ground
White:	neutral
Black:	live

3. Do not allow anything to rest on the power cord. Do not locate this product where persons will walk on the cord.

To disconnect the cord, pull it out by the plug. Never pull the cord itself.

4. If an extension cord is used with this product, make sure that the total of the ampere ratings on the products plugged into the extension cord does not exceed the extension cord ampere rating. Also make sure that the total of all products plugged into the wall outlet does not exceed 15 amperes.

5. Never push objects of any kind into this product

through cabinet slots as they may touch dangerous voltage points or short out parts that could result in a risk of fire or electrical shock.

Never spill liquid of any kind on the product. Should any liquid or solid object fall into the cabinet, unplug the set and have it checked by qualified service personnel before resuming operations.

6. Lightning - For added protection for this video product during a lightning storm, or when it is left unattended and unused for long periods of time, unplug it from the wall outlet. This will prevent damage to the projector due to lightning and AC power-line surges.

SAFETY INSTRUCTIONS

ON INSTALLATION

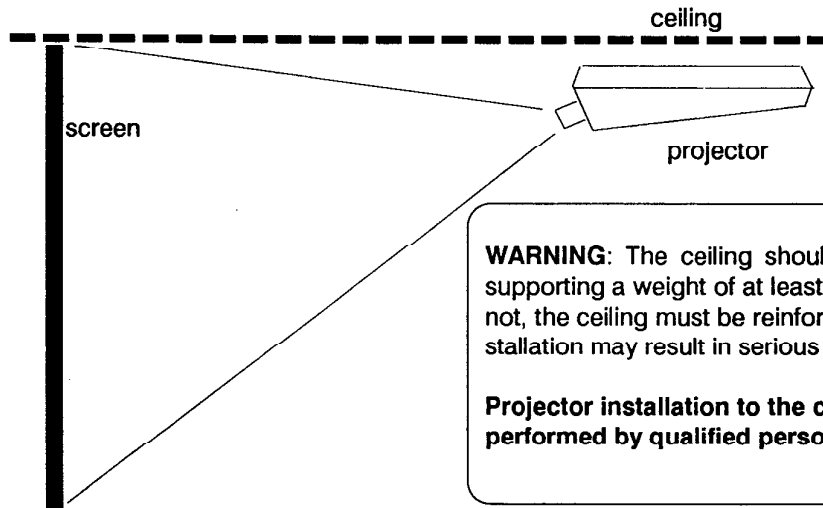

WARNING: The ceiling should be capable of supporting a weight of at least 250Kg(551LB). If not, the ceiling must be reinforced. Improper installation may result in serious personal injury.

Projector installation to the ceiling should be performed by qualified personnel only.

The projector is factory preset for front screen projection/table mounted and adjusted for a screen size of 2.40m x 1.80m (7.87Ft x 5.90Ft).

The projector can also operate in other configurations as well i.e. rear projection, ceiling mounted and for different screen sizes.

The screen sizes are limited to: - min screen size: 1.00m x 0.75m (3.28Ft x 2.46Ft)
- max screen size: 6.00m x 4.50m (19.68Ft x 14.76Ft)

WARNING: Only a qualified service representative or BARCO service center is authorized to change the configuration of this projector!

1. Do not place this projector on an unstable cart, stand, or table. The projector may fall, causing serious damage to it.
2. Do not use this projector near water.
3. Slots and openings in the cabinet and the back or bottom are provided for ventilation; to ensure reli-

able operation of the projector and to protect it from overheating, these openings must not be blocked or covered. The openings should never be blocked by placing the product on a bed, sofa, rug, or other similar surface. This product should never be placed near or over a radiator or heat register. This projector should not be placed in a built-in installation or enclosure unless proper ventilation is provided.

SAFETY INSTRUCTIONS

ON SERVICING

Do not attempt to service this projector yourself, as opening or removing covers may expose you to dangerous voltage potentials and risk of electric shock! **Refer all servicing to qualified service personnel.**

Unplug this product from the wall outlet and refer servicing to qualified service personnel under the following conditions:

- a. When the power cord or plug is damaged or frayed.
- b. If liquid has been spilled into the projector.
- c. If the product has been exposed to rain or water.

Replacement parts - When replacement parts are required, be sure the service technician has used original BARCO replacement parts or authorized replacement parts which have the same characteristics as the BARCO original part. Unauthorized substitutions may result in degraded performance and reliability, fire, electric shock or other hazards. Unauthorized substitutions may void warranty.

d. If the product does not operate normally when the operating instructions are followed.

Adjust only those controls that are covered by the operating instructions since improper adjustment of the other controls may result in damage and will often require extensive work by a qualified technician to restore the product to normal operation;

e. If the product has been dropped or the cabinet has been damaged;

f. If the product exhibits a distinct change in performance, indicating a need for service.

Safety check - Upon completion of any service or repairs to this projector, ask the service technician to perform safety checks to determine that the projector is in proper operating condition.

ON CLEANING

Unplug this product from the wall outlet before cleaning. Do not use liquid cleaners or aerosol cleaners. Use a damp cloth for cleaning.

- To keep the cabinet looking brand-new, periodically clean it with a soft cloth. Stubborn stains may be removed with a cloth lightly dampened with mild detergent solution. Never use strong solvents, such as

thinner or benzene, or abrasive cleaners, since these will damage the cabinet;

- To ensure the highest optical performance and resolution, the projection lenses are specially treated with an anti-reflective coating, therefore: avoid touching the lens. To remove dust on the lens, use a soft dry cloth. Do not use a damp cloth, detergent solution, or thinner.

SAFETY INSTRUCTIONS

ON REPACKING

Save the original shipping carton and packing material; they will come in handy if you ever have

to ship your projector. For maximum protection, re-pack your set as it was originally packed at the factory.

ON ILLUMINATION

In order to obtain the best quality for the projected image, it is essential that the ambient light which is allowed to fall on the screen be kept to an absolute minimum.

When installing the projector and screen, care must be taken to avoid exposure to ambient light directly on the screen. Avoid adverse illumination on the screen from direct sunlight or florescent lighting fixtures.

The use of controlled ambient lighting, such as incandescent spot light or a dimmer, is recommended for proper room illumination. Where possible, care should also be taken to ensure that the floors and walls of the room in which the projector is to be installed are non-reflecting, dark surfaces. Brighter surfaces will tend to reflect and diffuse the ambient light and hence reduce the contrast of the projected image on the screen.

LOCATION AND FUNCTIONS OF CONTROLS

LOCATION AND FUNCTIONS OF CONTROLS

REAR PANEL TERMINOLOGY

FRONT PANEL TERMINOLOGY

RCU800 TERMINOLOGY

LOCATION AND FUNCTIONS OF CONTROLS

REAR PANEL TERMINOLOGY

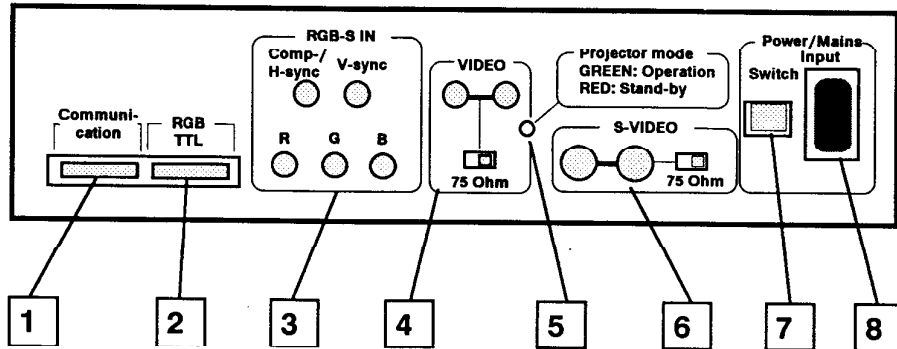

- 1** **Communication port RCVDS-Remote :**
* allows communication between the RCVDS switcher and the projector.
* allows connection of a remote IR receiver unit to the projector.
- 2** **RGB TTL Input (9-pins female D-connector, CGA and EGA compatible):** allows a character generator, microcomputer, etc. having digital outputs to be connected.
- 3** **RGB-S IN (5x BNC connector):** allows a character generator, microcomputer, video camera, etc. having analog RGB output to be connected.
- Line inputs: - color signals RED-GREEN-BLUE
- VERT. sync. signal
- COMPOSITE or HOR. sync. signal
- 4** **VIDEO IN (Composite video, 2x BNC connector):** allows a video tape recorder, video camera, color receiver/monitor, etc. having video line output to be connected.
- When no loop-through connection is desired, put the 75 ohm line termination switch in the ON position.

LOCATION AND FUNCTIONS OF CONTROLS

REAR PANEL TERMINOLOGY

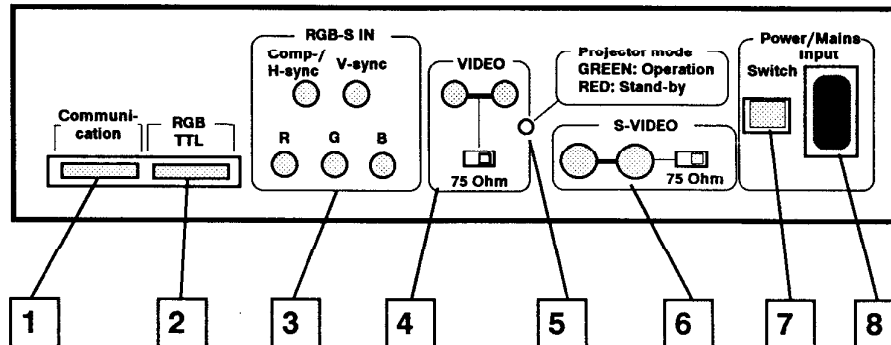

5 PROJECTOR PILOT LAMP: indicates the status of the projector.

- doesn't light up: mains (power) switch is not pressed.
- lights up: mains (power) switch is pressed and the lighting color indicates the projector mode:

GREEN color: operation mode of the projector
RED color: STANDBY mode of the projector.

Important: projector mode ("**operational**" or "**standby**") defined during the installation of the projector. (Refer to a qualified technician for change)

6 S-VIDEO IN: Separated Y/C (luma-chroma) signal inputs and outputs for higher quality dubbing and playback of Super VHS signals (4-pin S-VIDEO IN and S-VIDEO OUT).

When no loop-through connection is desired, put the 75 ohm line termination switch in the ON position.

7 POWER (MAINS) SWITCH : press the switch to turn the projector ON.

Depending on the hardware set-up of the projector during installation, the projector switches to '**standby**' or to '**operational mode**' (refer to explanation of pilot lamp [5]).

8 POWER (MAINS) INPUT: Connect the supplied ac power (mains) cord here and to wall the outlet.

LOCATION AND FUNCTIONS OF CONTROLS

FRONT PANEL TERMINOLOGY

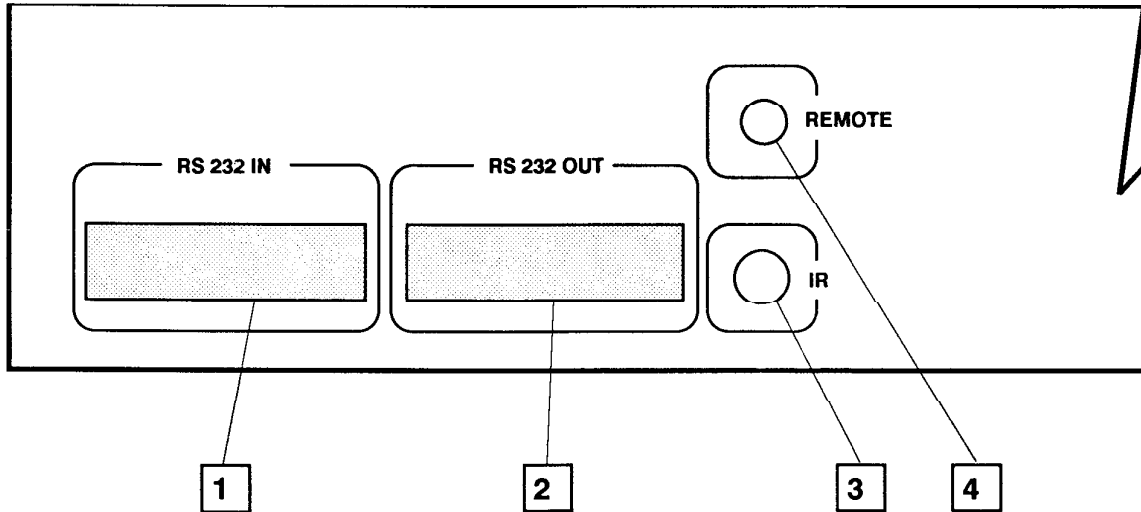

- 1** **RS232 IN** : connection between the BARCOGRAPHICS 800 and a IBM PC (or compatible) or a MAC for remote computer control and data communication
- 2** **RS232 OUT** : to next projector, RS232IN plug (communication link for PC or MAC to the next projector).
- 3** **IR input** : receiver for control signals transmitted from the RCU800.
- 4** **REMOTE** : remote input for wired remote control by the RCU800.

LOCATION AND FUNCTIONS OF CONTROLS

RCU800 CONTROL PANEL TERMINOLOGY

This remote control allows for each connected input source separately a set-up and an automatic storing of:

- analog controls (Brightness, Sharpness,...)
- picture geometry adjustments
- convergence adjustments

Other functions on the remote control are:

- switching to standby and to operational mode
- switching to "pause" (blanked picture, full power for immediate restarting)
- direct access to all connected sources
- variable adjustment speed : when pushing continuously on an adjustment button, the adjustment will be executed in a quicker way.

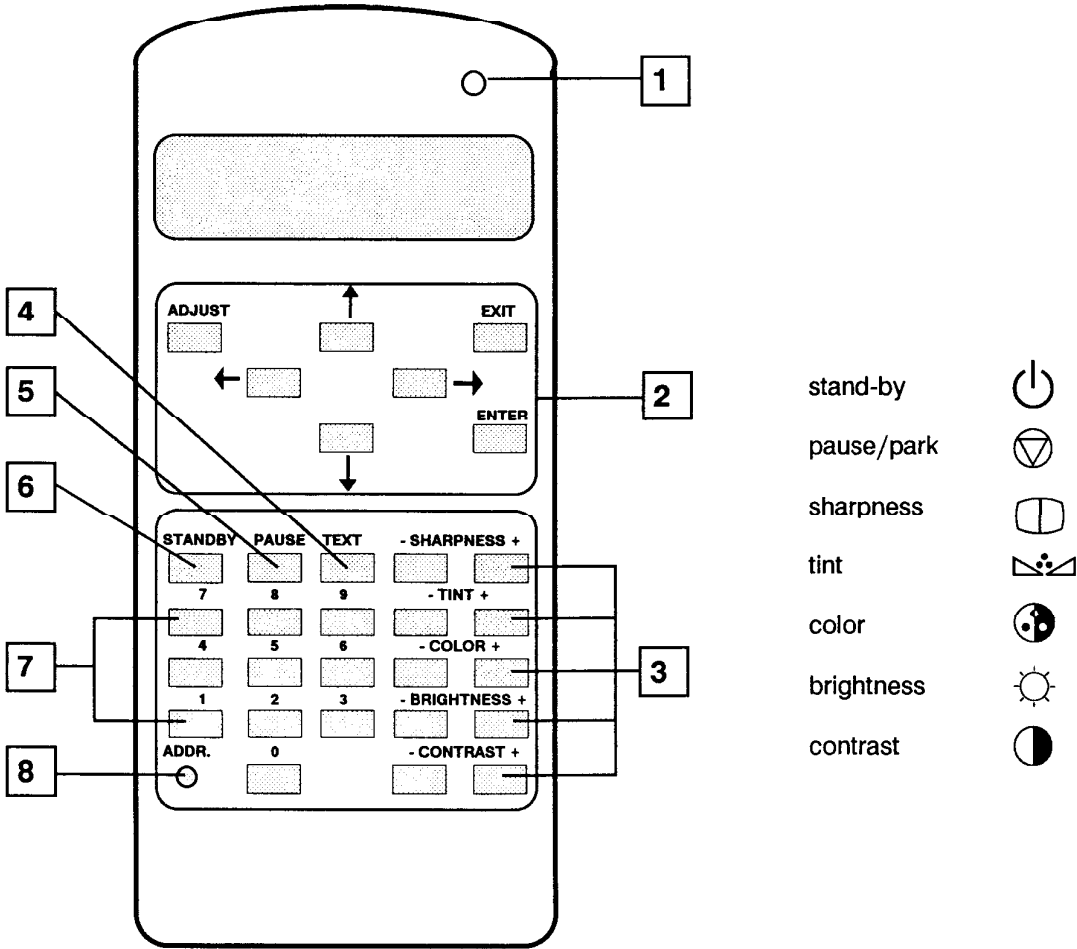

1 RC operating indicator: lights when a button on the remote control is pressed. (This indicator is a visual control for the user if the remote control works perfect).

2 ADJUSTMENT-SETTINGS KEYS: these keys are used for picture geometry and convergence adjustments.

LOCATION AND FUNCTIONS OF CONTROLS

RCU800 CONTROL PANEL TERMINOLOGY

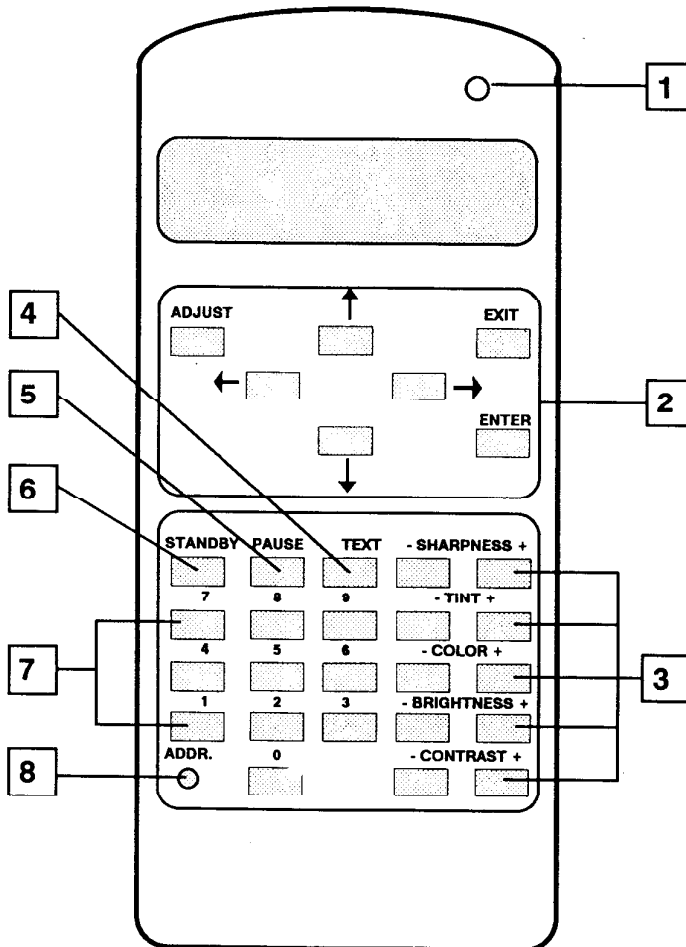

- 3** **ANALOG PICTURE CONTROLS** : use these buttons to obtain the desired image analog level (refer to chapter 'Controlling').
- 4** **'TEXT' key** : with 'TEXT' off, no information will be displayed during an analog adjustment and no warnings and no errors will be displayed. "TEXT" key is only active in operational mode.
- 5** **'PAUSE' key** : to stop projection for a short time, press "PAUSE" key. The image disappears, but full power is retained for immediate restarting.
- 6** **STANDBY**: to stop projection for a longer time without power off, press "STAND-BY" key to switch the projector in the standby position.
- 7** **DIGIT BUTTONS**: direct input selection
- 8** **ADDRESSED PROJECTOR (between 0 and 9)**: press "address", followed by pressing one digit button, between 0 and 9.

LOCATION AND FUNCTIONS OF CONTROLS

CONTROLLING THE PROJECTOR WITH THE RCU800

Via the REFLECTIVE screen surface

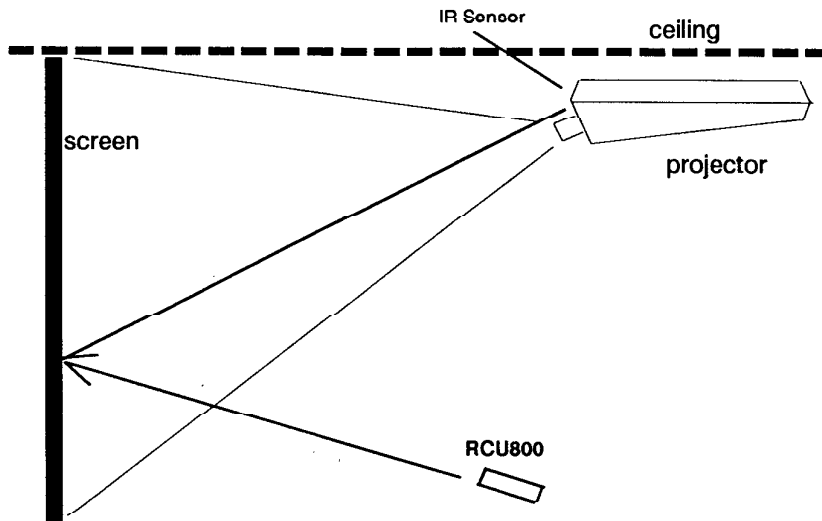

Direct control

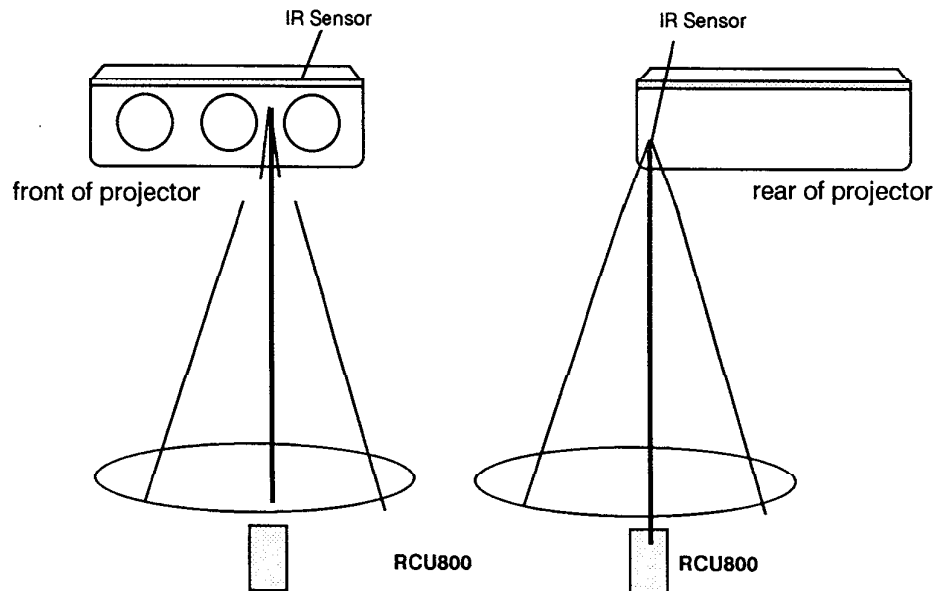

When using the wireless remote control, make sure you are within the effective operating distance. The remote control unit will not function properly if strong light strikes the sensor window or if there are obstacles between the remote control unit and the projector IR receiver.

LOCATION AND FUNCTIONS OF CONTROLS

Notes

POWER (MAINS) CONNECTION

POWER (MAINS) CONNECTION

POWER (MAINS) CONNECTION

1. Power (mains) cord connection

Power (Mains) input : Male power connector at the rear of the projector.

Attention :

Before plugging the female power connector into the male connector on the projector put the connector clamp in the clamp holder.

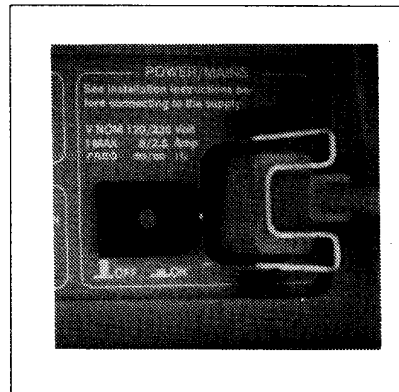
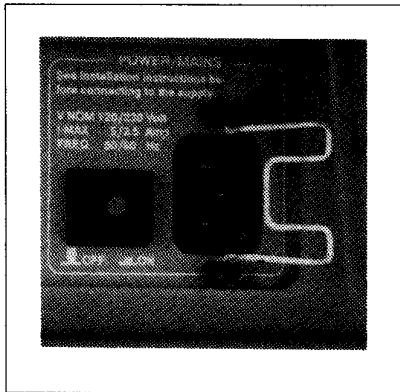
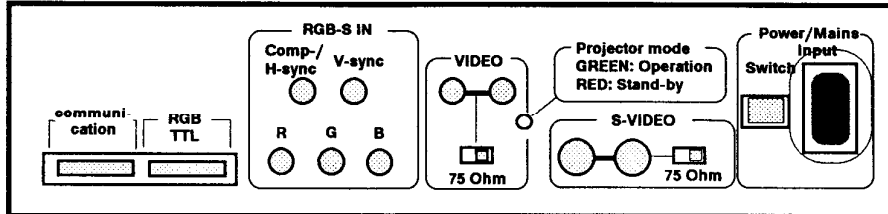

* Power check

Warning

Check by looking through the little window on the top cover if the indicated power voltage corresponds to that of the wall outlet.

If the indication is different from that of the wall outlet, call a qualified technician for power adaptation of the projector.

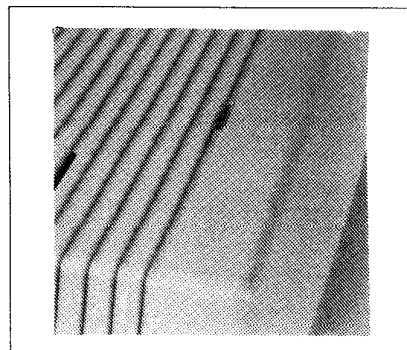
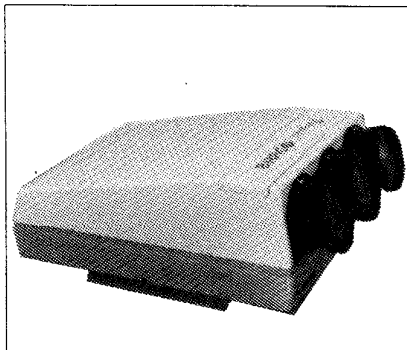

POWER CONNECTION

* Power cord connection

With the projector switched off, first attach the power cord to the projector and then to the wall outlet.

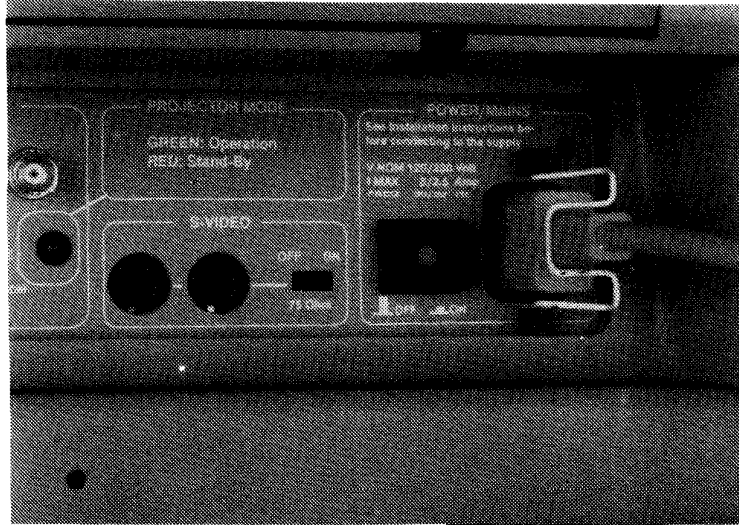

2. Switching on

The projector is switched ON and OFF using the power (main) switch ON/OFF.

Pressed : ON

Not pressed : OFF



Power indication lamp :

Green : projector in operational mode
Red : projector in stand-by mode

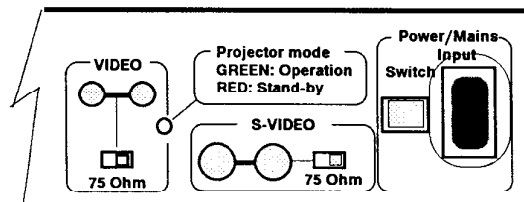

The projector can start now in the 'operational mode' (image displayed) or in the 'stand-by mode', depending on the position of the 'power up' dip switch on the controller unit. This DIP switch is set during installation by a qualified technician. If you want to change this start up mode, call a qualified technician.

POWER CONNECTION

Notes

SOURCE CONNECTIONS

SOURCE CONNECTIONS

INPUT SOURCES

EXAMPLES OF SOURCE CONNECTIONS

SOURCE CONNECTIONS

Signal input connections to a stand alone projector : * Composite Video
 * S-Video
 * RGB TTL
 * RGsB - RGB/S

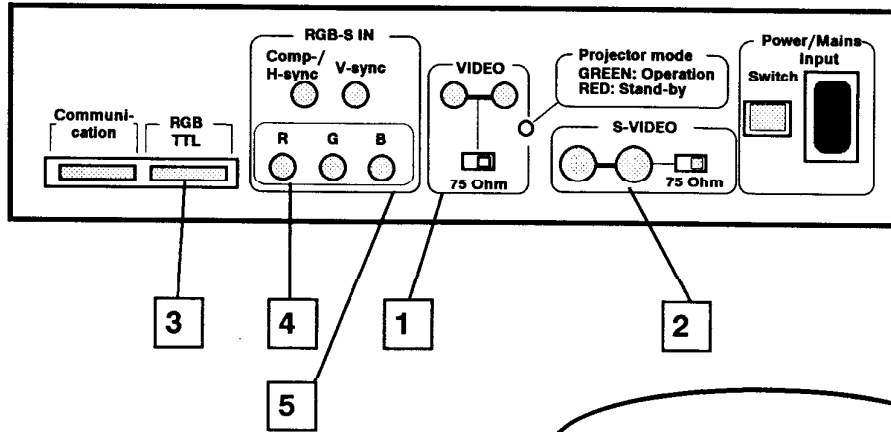

SOURCE Nr	PROJECTOR INPUT	PRESS DIGIT BUTTON
1	COMP VIDEO	1
2	S-VIDEO *	2
3	RGB TTL	3
4	RGsB **	4
5	RGB/S ***	5

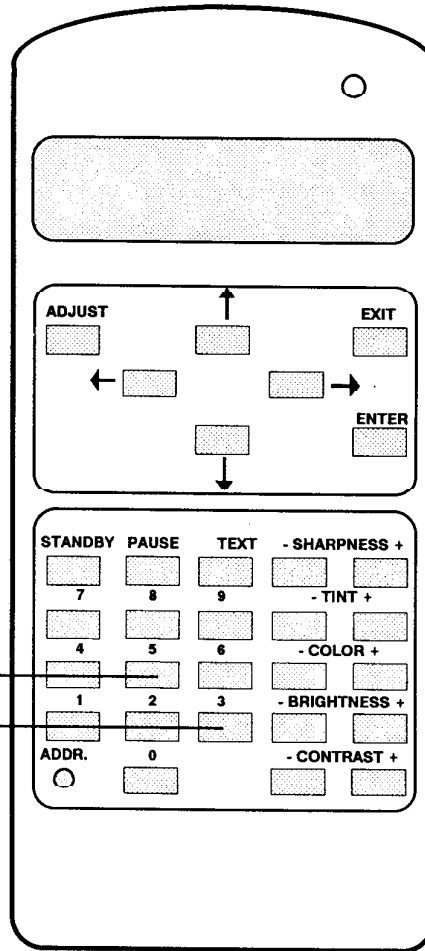

* Input signal Y/C (luma/chroma)
 ** Input signal: R,G and B with sync on G
 *** Input signal: R,G,B and separate sync(S)

EXAMPLES OF CONNECTIONS

Connecting a COMPOSITE VIDEO source to input 1

Composite video signal from a VCR, OFF air signal decoder, etc...

COMPOSITE VIDEO INPUT SELECTION: PRESS digit button 1 on the RCU800

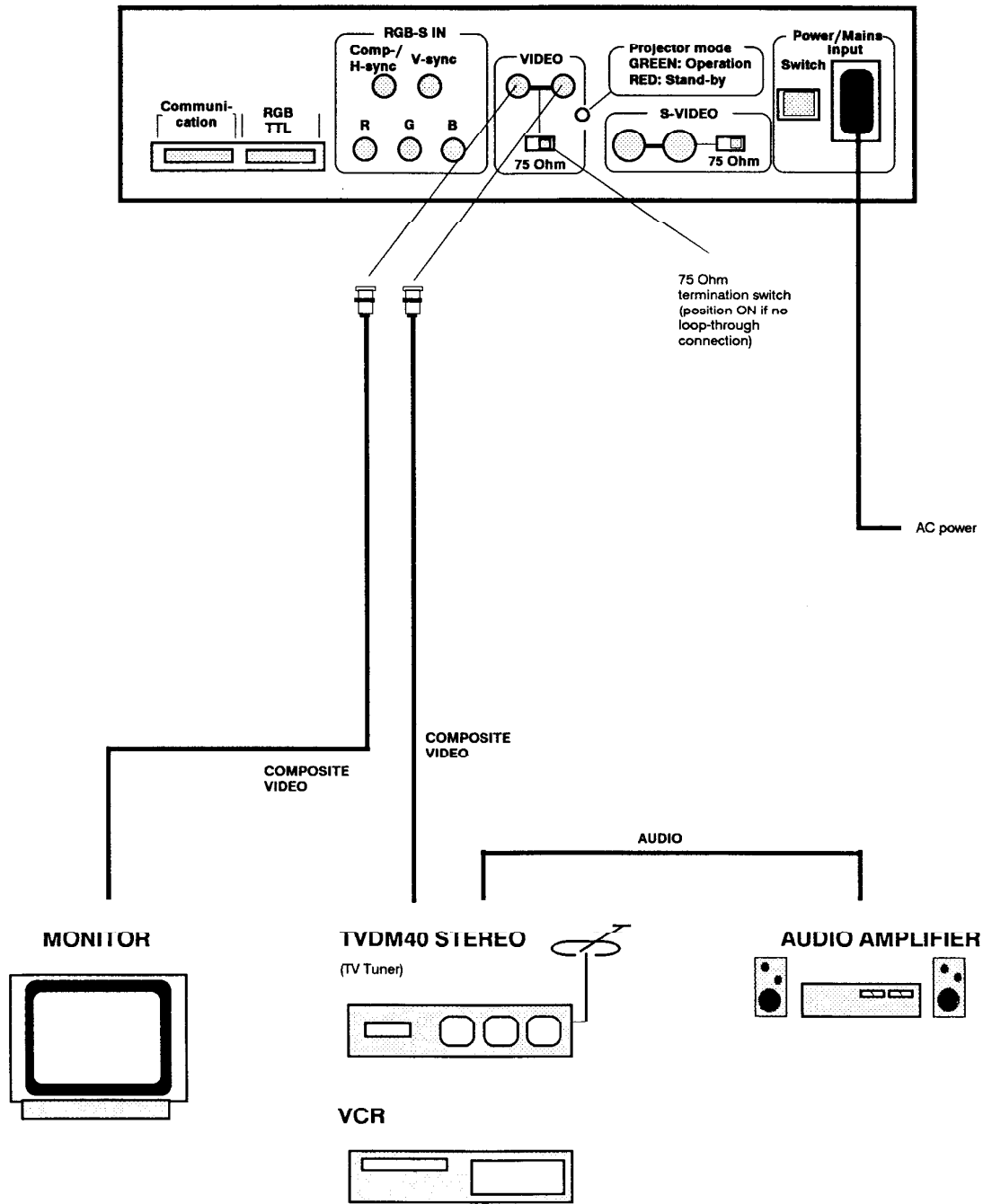

EXAMPLES OF CONNECTIONS

Connecting a S-VIDEO source to input 2

Separated Y-Luma / C-Chroma signal inputs for higher quality playback of Super VHS-signals

S-VIDEO INPUT SELECTION: PRESS digit button 2 on RCU800.

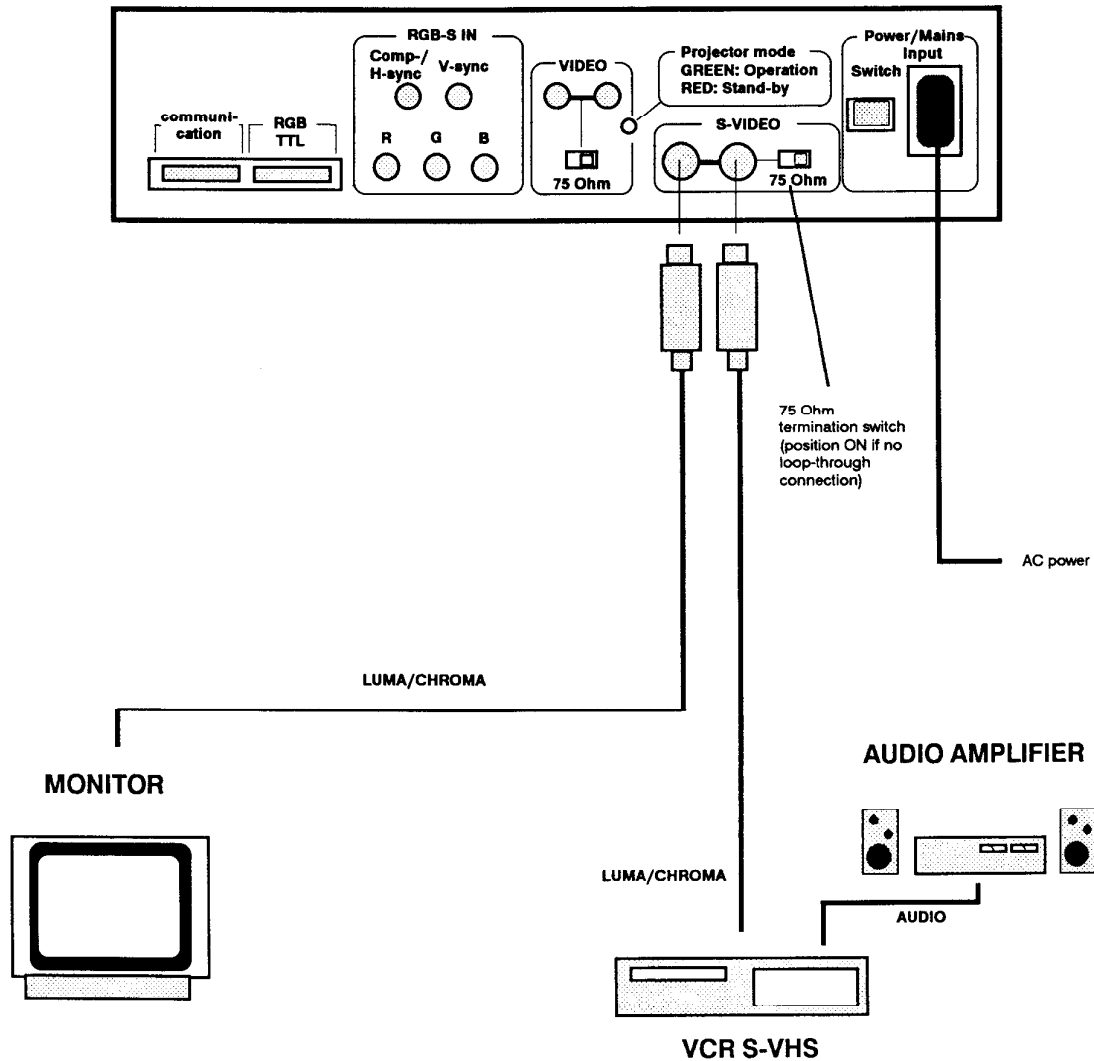

EXAMPLES OF CONNECTIONS

Connecting a RGB Analog source to the analog Inputs of the projector.

RGB analog input terminals with separate H and V sync inputs, with composite sync input or with sync signals on green.

Always use an interface when a computer and local monitor has to be connected with the projector. Interfaces to be applied :

- universal analog interface. Order number 98 26100
- RGB 120 MHz analog interface. Order number 98 26570
- RGB analog interface system 2. Order number 98 26610

RGsB input selection : press digit button 4 on the RCU800

(RGsB : R, G, B signals with sync on GREEN)

RGB/S input selection : press digit button 5 on the RCU800

(RGB/S : R, G, B and separate sync; H- and V- sync or COMP sync)

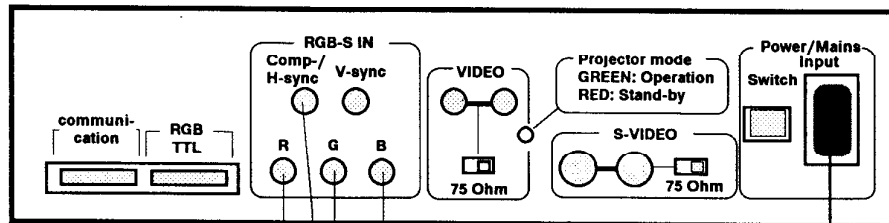

ATTENTION!

The RGB Analog 120 MHz interface has no separate output for vert. sync.

to AC IN
AC power cord supplied
to a wall outlet

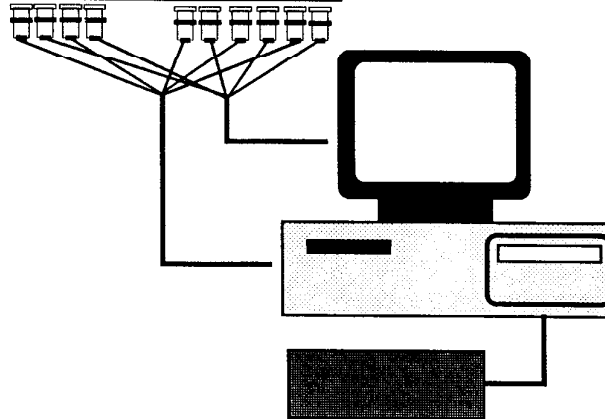

EXAMPLES OF CONNECTIONS

Connecting a RGB TTL source to the RGB TTL input of the projector.

Connect your TTL source via an interface to the TTL input. (BARCO order number : 98 26110)

The TTL input is specially designed for signals which follow the CGA and EGA standard. It switches automatically between those two standards.

RGB TTL INPUT SELECTION: PRESS digit button 3 on the RCU800 unit

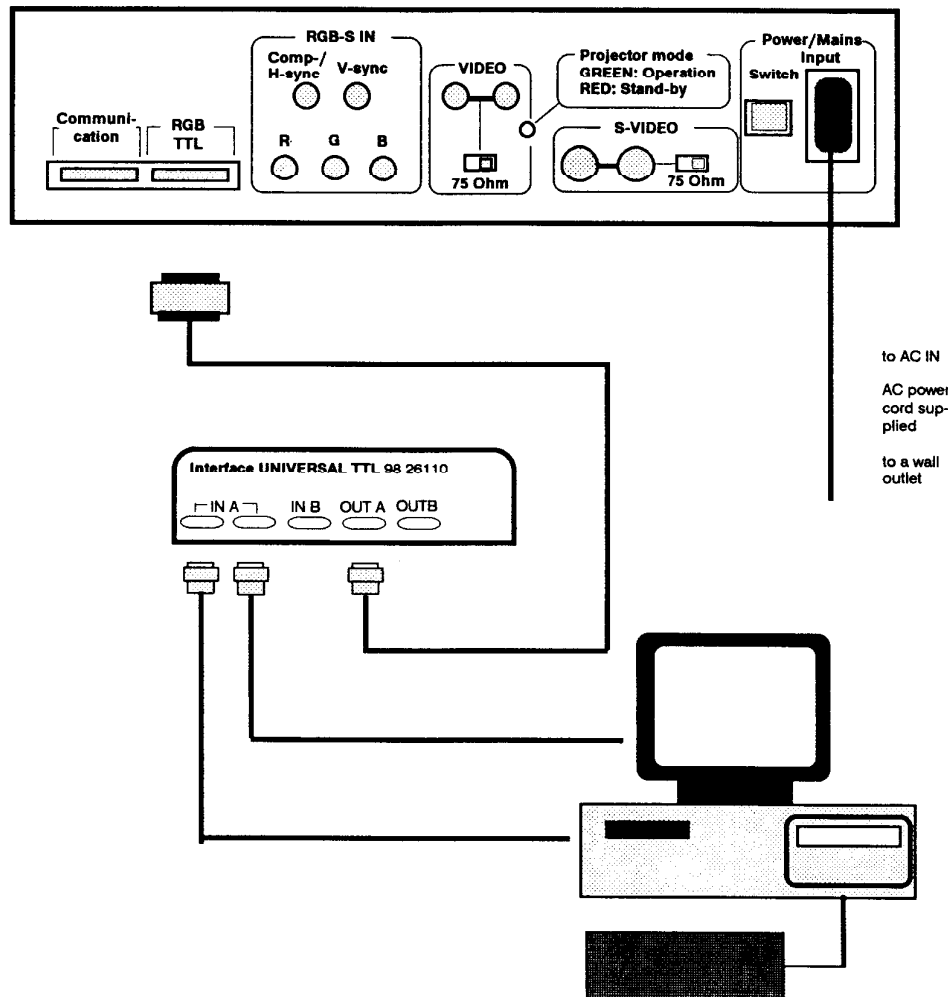

Pin configuration D9 connector of the TTL input

EGA configuration	CGA configuration
1 ⊥	⊥
2 red	-
3 RED	RED
4 GREEN	GREEN
5 BLUE	BLUE
6 green	intensity
7 blue	-
8 Hor/comp sync	Hor/comp sync
9 Vert sync	Vert sync

EXAMPLES OF CONNECTIONS

Connecting a RGB TTL (EGA) source to the projector.

Connecting a RGB TTL (EGA) source using the universal TTL/Analog interface (BARCO order number : 98 26020)

Connect your EGA source to the interface and feed the output signal of the interface with coaxial cables to the RGB analog input of the projector. The projector will treat it as a RGB analog source

RGB-S input selection : press digit button 5 on the RCU800
(RGB-S : R, G, B and composite sync)

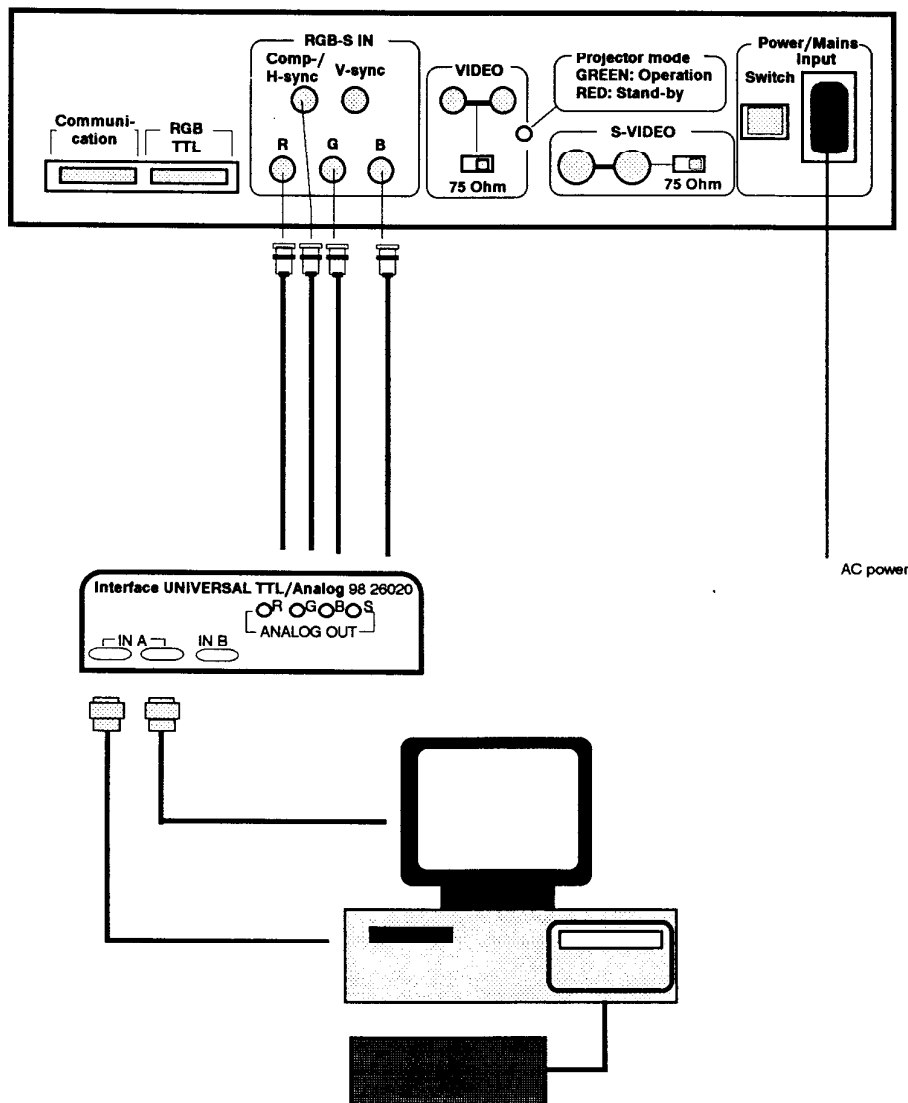

EXAMPLES OF CONNECTIONS

Connecting an IBM PS/2 computer to the projector.

To feed this source to the BARCOGRAPHICS 800 use the RGB analog automatic sync system 2 interface. (BARCO order number : 98 26610).

Connect your computer to the interface (instruction sheet is inclosed in the packing of the interface) and feed the interface output signals with coaxial cables to the RGB analog input of the projector. The projector will treat it as a RGB analog source.

RGB-S input selection : press digit button 5 on the RCU800.
(RGB-S : R, G, B, composite sync)

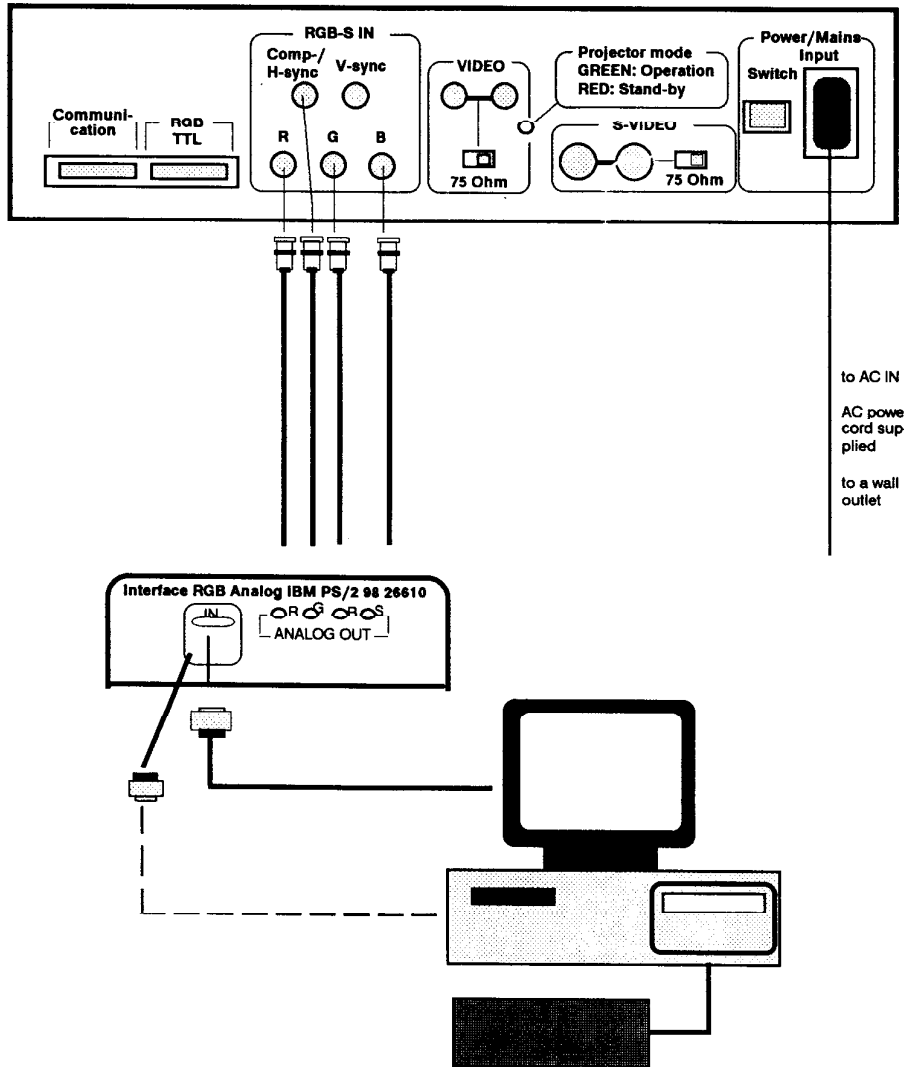

PROJECTOR CONTROL

CONTROLLING

CONTROLLING STAND ALONE PROJECTORS WITH THE RCU800

CONTROLLING CHAINED PROJECTORS WITH THE RCU800

Caution : Do not display a stationary image with full brightness and contrast for longer than 20 min., otherwise you risk damage to the CRT's.

PROJECTOR CONTROL

Stand alone projector

1. The RCU800

The stand alone projector can be controlled by the RCU800; which you can use in three different configurations :

- a) The built in RCU800.
- b) The IR transmission RCU800.
- c) The hardwired RCU800

a) *The built in RCU800.*

This RCU800 is built to the rear of the projector. To gain access to it, unscrew the retaining screw and rotate the RCU800 90°.

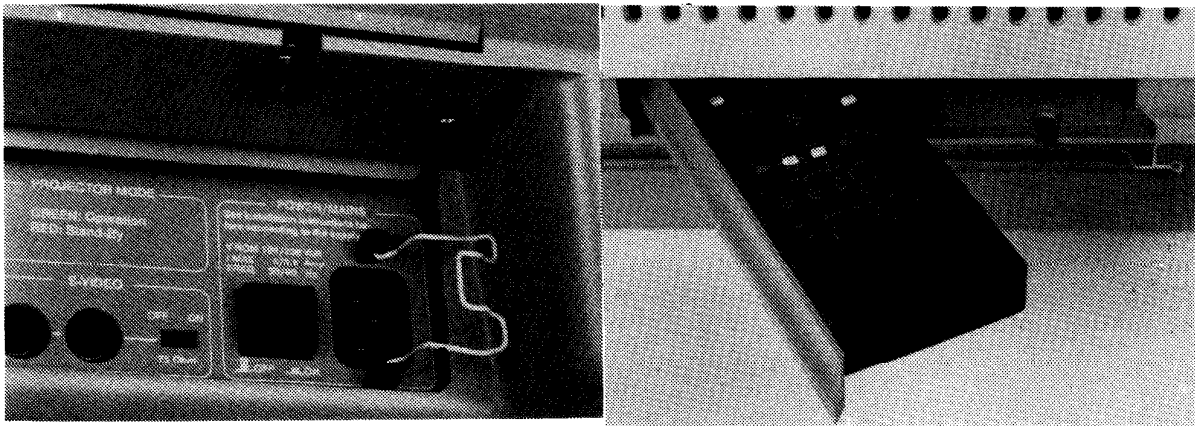

b) *The IR transmission RCU800.*

This remote control is included with the BARCOGRAPHICS 800. When using this remote control, make sure that the projector address is programmed on the remote control (see § Selecting the address).

c) *The hardwired RCU800.*

The IR transmission RCU800 may also be used in a hardwired configuration. Plug one end of the remote cable in the connector on top of the RCU800 and the second side in the connector in the front panel of the BARCOGRAPHICS 800 labelled 'remote control'.

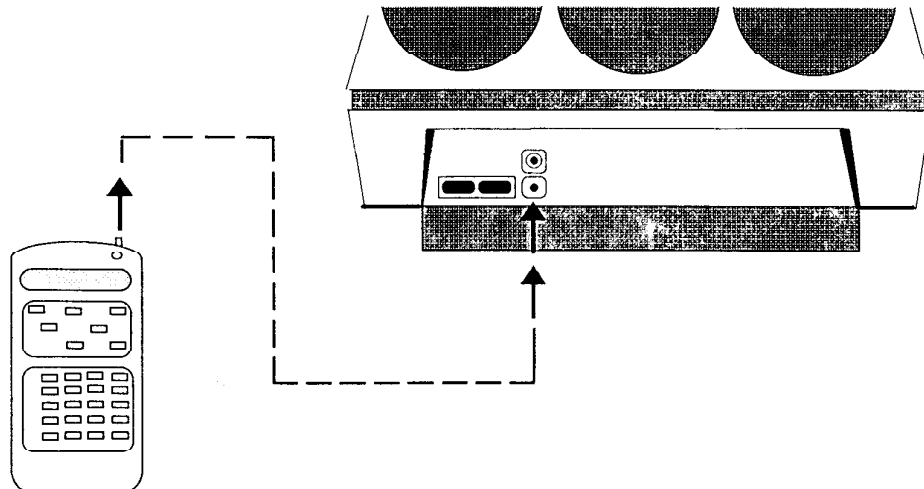

PROJECTOR CONTROL

2. Controlling stand alone projector with the RCU800.

A. Selecting the address.

Every projector requires an individual address. Otherwise, it is not possible to control the projector. The address setting of the projector must be done during the hardware set up by a qualified technician. Once the projector is installed, the RCU800 must be programmed with the address of the the projector it controls.

Address display : When pressing with a pencil or other small object in the hole labelled ADDR on the RCU800, the projector's address will be displayed. Now, it is necessary to enter an address with the numeric keys.

Address programming : . The address of an individual projector may be programmed into the RCU800 by keying in the address with the numeric keys after activating 'ADDR' on the RCU800. (With RCU800, only between 0 and 9).

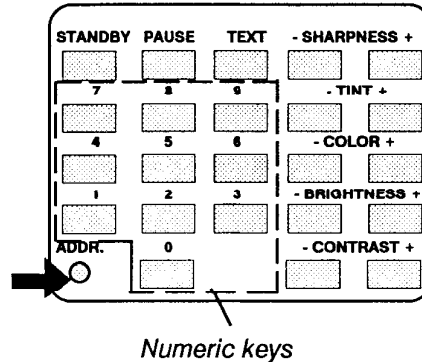

Zero address : If the RCU800 is programmed with an address of 0 (zero), it will control a projector regardless of the projector's address. This feature allows multiple projectors with differing addresses to be controlled by a single RCU800.

B. Selecting an input source.

SOURCE Nr	PROJECTOR INPUT	PRESS DIGIT BUTTON
1	VIDEO	1
2	S-VIDEO *	2
3	RGB TTL	3
4	RGsB **	4
5	RGB/S ***	5

With the numeric keys, 1 to 5, on the RCU800, it is possible to select one of the five inputs.

When a valid and available source is selected, there will be information displayed on the screen about that source.

This information includes :

- source number
- horizontal frequency
- vertical frequency

- * Input signal Y/C (luma/chroma)
- ** Input signal: R,G and B with sync on G
- *** Input signal: R,G,B and separate sync's

Source information in example :
source 02 = S-Video input signal with horizontal frequency of 15625 Hz and a vertical frequency of 50 Hz.

SOURCE 02
Fh = 15625 Hz
Fv = 50 Hz

PROJECTOR CONTROL

When the entry is a not valid source number, a warning appears on the screen : 'invalid key entry'.

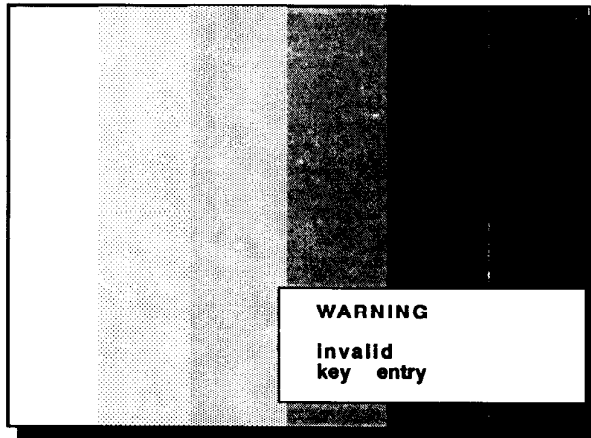

Until software version 2.03 :

When there is something wrong with the source (e.g. no coincidence) the projector will retry to select that source 5 times with an interval of 20 seconds. If no succes, it goes to the Barco start up screen. When reselecting the same source without succes, a message 'source not available' will be displayed.

For software version 2.04 or higher :

When a valid source number is selected, the projector will display this source or it will wait on the selected source number until the source becomes available. No message will be displayed.

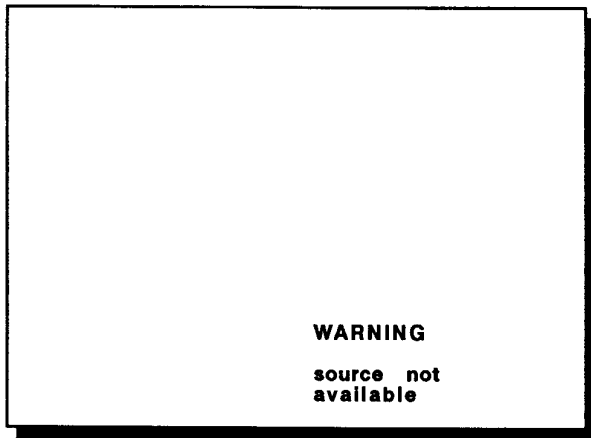

C. Analog picture controls

When an analog picture control is pressed, a bar scale and a number below the bar scale (between 0 and 100) appear on the screen with the function name of the control, e.g. "brightness" above it and. The length of the bar scale and the number (between 0 and 100) Indlcate the current setting for this source. The bar scale changes as the + or - buttons of the control are pressed.

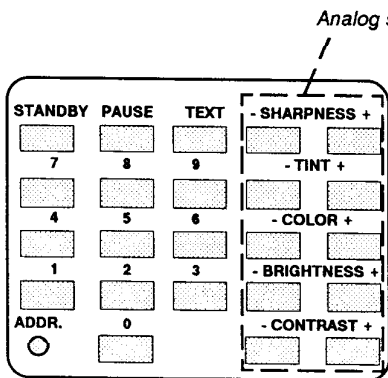

The appearance of the text, bar scale and number can be prevented by pressing the 'TEXT' key on the RCU800. This button acts as a toggle switch, switching between text 'ON' and 'OFF' each time the button is pressed. The latest position is memorized and is recalled every time this source is chosen, even when the power to the projector is switched OFF and ON again. The analog picture controls can be adjusted with the RCU800 in 'adjustment mode' as well as in 'operational mode'.

PROJECTOR CONTROL

a) Brightness control

Brightness control for Video, S-video and RGB sources.

A correct 'brightness' setting is important for a good color reproduction.

Adjust the Brightness with the + button and - button until the darkest parts of the picture appear as black.

A bar scale and number below the bar scale (between 0 and 100) give a visual indication on the screen of the current brightness setting while pressing the + or - buttons. If the bar scale is not visible on the screen, press 'TEXT' key once and retry the + or - keys.

The bar scale and numeric indicator increase when pressing on the + button (higher brightness) and decrease when pressing on the - button (lower brightness).

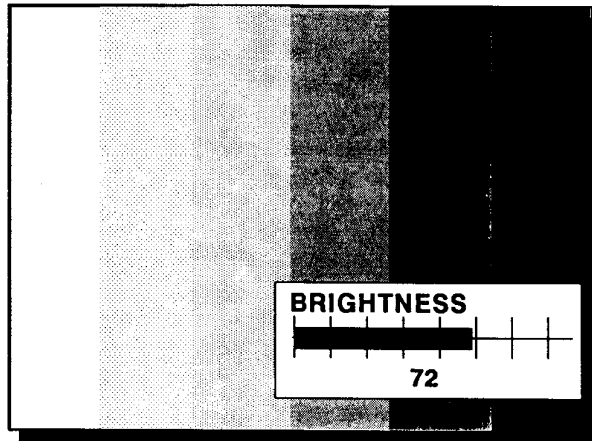

b) Contrast control.

Contrast control for Video, S-video and RGB sources.

A correct 'contrast' setting is important for a good color reproduction.

Adjust the contrast to the level you prefer, according to room lighting conditions.

A bar scale and a number below the bar scale (between 0 and 100) give a visual indication on the screen of the current contrast setting while pressing the + or - buttons. If the bar scale is not visible on the screen, press 'TEXT' key once and retry with the + or - keys.

The bar scale and numeric indicator increase when pressing the + button (higher contrast) and decrease when pressing on the - button (lower contrast).

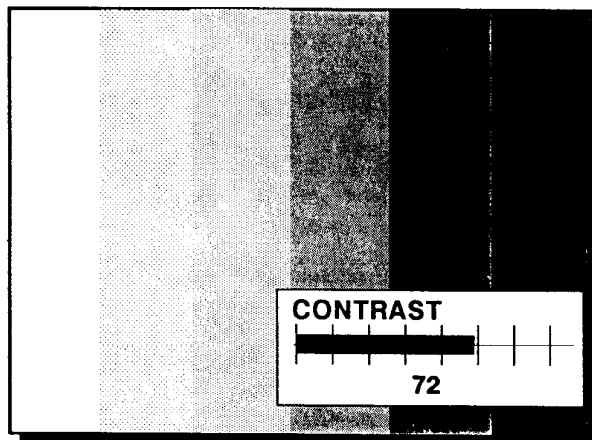

c) Color saturation

Color saturation control for Video and S-video.

Adjust the color intensity of the picture. Use the + and - button on the remote control panel.

A bar scale and a number below the bar scale give a visual indication on the screen of the current color setting while pressing of the + or - buttons. If the bar scale is not visible on the screen, press 'TEXT' key once and retry the + or - keys.

The bar scale and numeric indicator increase when pressing on the + button (richer colors) and decrease when pressing the - button (lighter colors).

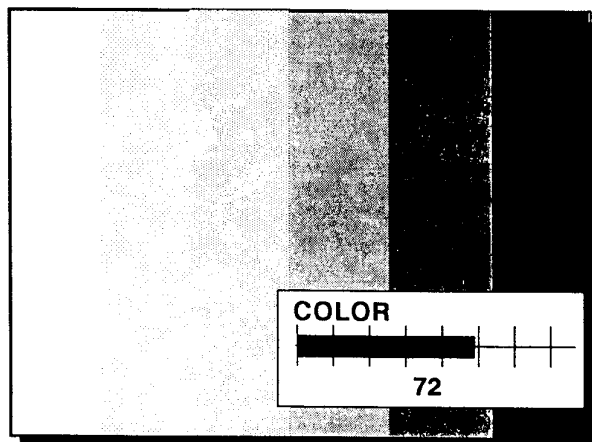

PROJECTOR CONTROL

d) Tint control

Tint control for Video and S-video.
This control is effective only when using the NTSC 4.43 or NTSC 3.58 system.

A bar scale and number below the bar scale (between 0 and 100) give a visual indication on the screen of the current tint setting while pressing the + or - buttons. If the bar scale is not visible on the screen, press the 'TEXT' key once and retry the + or - keys.

The bar scale and numeric indicator increase when pressing on the + button and decrease when pressing the - button.

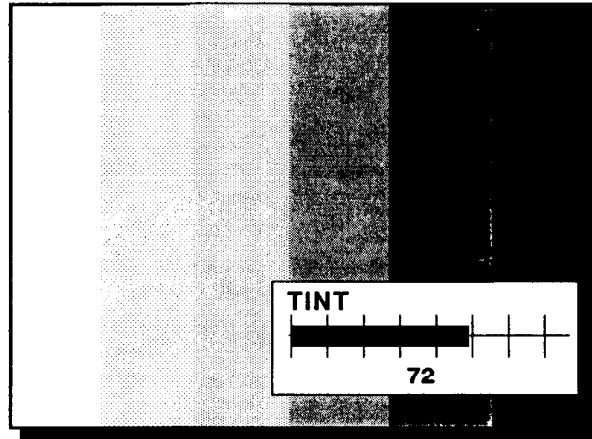

e) Sharpness control

Sharpness control for Video and S-video.
A bar scale and a number below the bar scale (between 0 and 100) give a visual indication on the screen of the current sharpness setting while pressing the + or - buttons. If the scale bar is not visible on the screen, press 'TEXT' key once and retry the + or - keys.

The bar scale and numeric indicator increase when pressing on the + button (sharper picture) and decrease when pressing on the - button (softer picture).

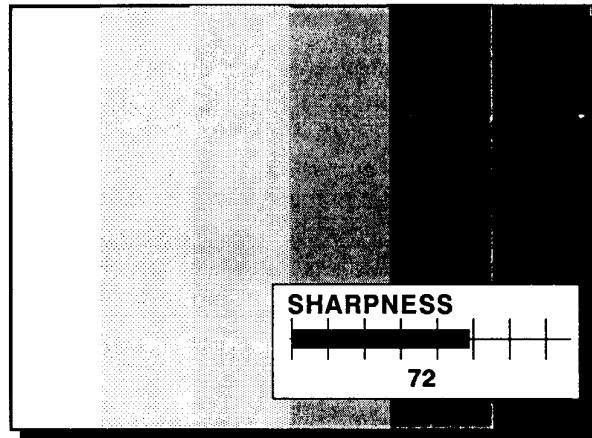

PROJECTOR CONTROL

Chained projectors

1. The RCU800

Use the standard RCU800 to control chained projectors. For address setting, source selection and analog controls see § Controlling chained projectors.

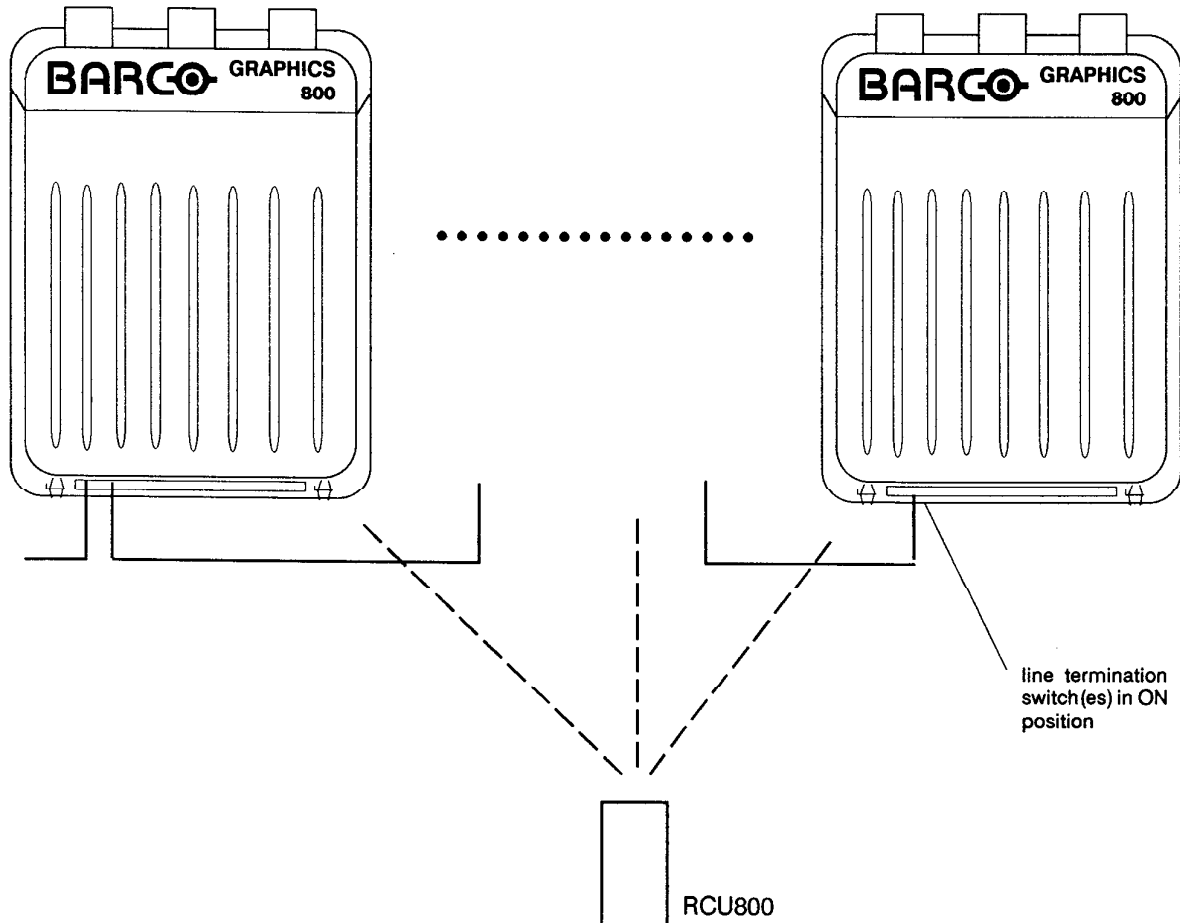

2. Controlling chained projectors

A. Address setting

Note :
Every projector requires an individual address. Otherwise, it is not possible to control the projector. The address setting of the projector must be done during the hardware set up by a qualified technician. Once the projector is installed, the RCU800 must now also be programmed with the address of the projector's it controls.

Address display : When pressing with a pencil or other small object in the hole labelled ADDR on the RCU800, the projector address will be displayed. Now, it is necessary to enter an address with the numeric keys.

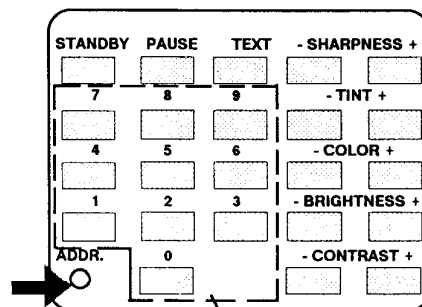

Numeric keys

PROJECTOR CONTROL

Address programming : The RCU800 is programmable with that individual projector address or with its 'zero address'.

To program the address, activate first 'ADDR' and key in the address with the numeric keys on the RCU800 itself.

Zero address : master address, independent the hardware set up, for controlling all the BARCOGRAPHICS 800's at once. So, the chain of projectors is addressable with the 'zero address' and an individual projector in the chain is addressable with its individual address (set during projector set up). When using that zero address, program the RCU800 as explained above.

B. Selecting an input source

As the projectors have to display the same input source, the RCU800 must be programmed with the 'zero address' before selecting an input source.

SOURCE Nr	PROJECTOR INPUT	PRESS DIGIT BUTTON
1	COMP. VIDEO	1
2	S-VIDEO *	2
3	RGB TTL	3
4	RGsB **	4
5	RGB/S ***	5

* Input signal Y/C (luma/chroma)
** Input signal: R,G and B with sync on G
*** Input signal: R,G,B and separate sync's

Attention

Once address '0' is pressed all projectors will be controlled until a new address is entered on the RCU800. Once this new address is entered, only the projector with this address will follow the new instructions.

C. Analog picture controls

With the RCU800 programmed with the 'zero address' all BARCOGRAPHICS 800 will be controlled in the same way. When one projector has to be adjusted, use the individual projector address to control this specific BARCOGRAPHICS 800.

For explanation about the analog controls, see § Stand alone projector controlled with the RCU800.

INSTALLATION ADJUSTMENT MODE

INSTALLATION ADJUSTMENT MODE

ACCESS TO OPTICAL CONTROLS

ENTERING THE ADJUSTMENT MODE (FLOW CHART)

ADJUSTMENT MODE

OVERVIEW FLOWCHART INSTALLATION ADJUSTMENT MODE

INSTALLATION ADJUSTMENT PROCEDURE

OPTICAL LENS FOCUSING

RASTER CENTERING

CRT ANGLE CORRECTION

LEFT-RGHT, TOP-BOTTOM FOCUSING

INSTALLATION ADJUSTMENT MODE

ACCESS TO OPTICAL ADJUSTMENTS.

The top cover of the BARCOGRAPHICS 800 has a unique user friendly design. The upper part of the cover with the projector logo can be opened in order to gain access to the optical adjustments.

Opening procedure :

The cover with the projector logo can be opened by pressing once on this part of the cover. A 'Click' will be heard. Then you can turn it 90° to the rear of the projector.

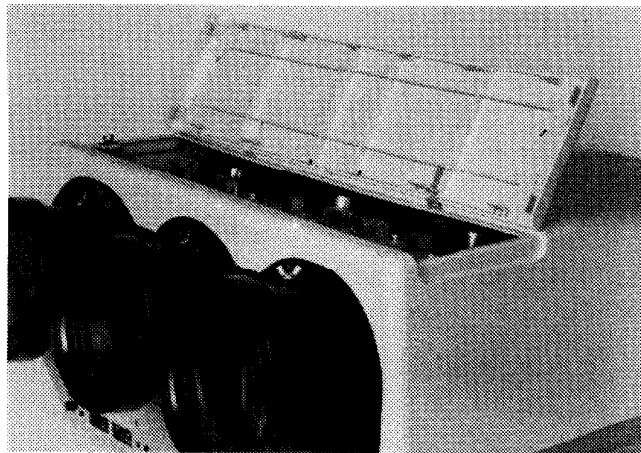
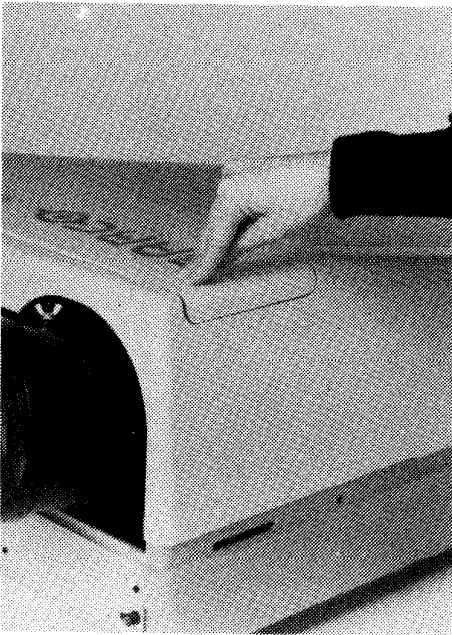

Closing the cover:

Rotate the cover into its center holes and press once on the cover. A 'click' will be heard again. The cover is now locked.

INSTALLATION ADJUSTMENT MODE

Entering the adjustment mode.

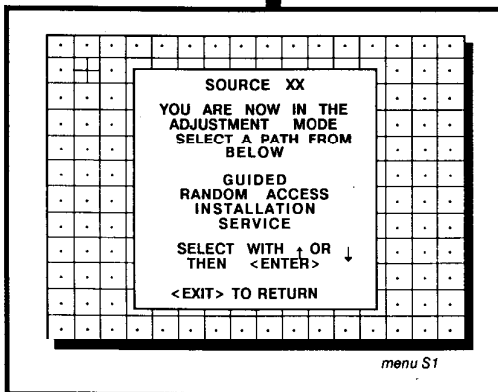
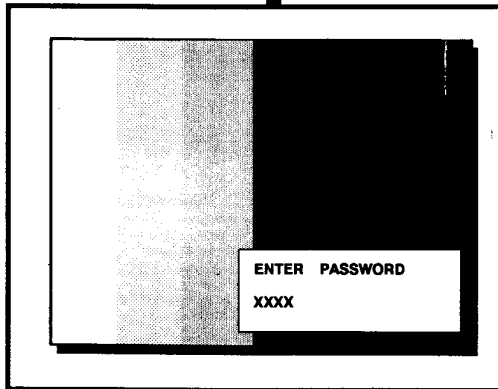
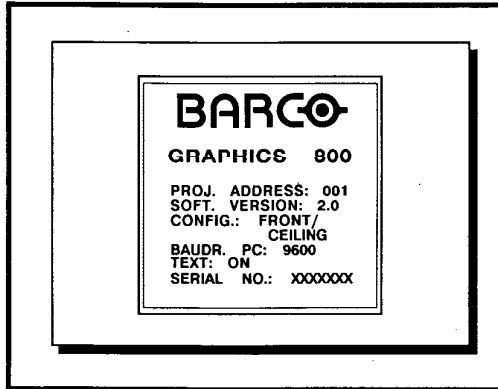

INSTALLATION MODE

SERVICE MODE

RANDOM ACCESS OR GUIDED ADJUSTMENT
MODE

INSTALLATION ADJUSTMENT MODE

ADJUSTMENT MODE

All picture geometry and convergence adjustments are made while in the 'Adjustment Mode'. To enter the Adjustment Mode, press the **ADJUST** key on the RCU800.

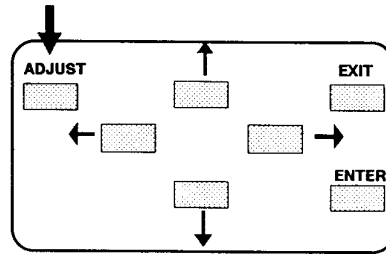

The projector asks you to enter your password.

Your password contains 4 digits. Enter the digits with the numeric keys on the RCU800.

Example : 2 3 1 9

For each digit entered, a cross appears on the screen under the displayed text 'enter password'.

When your password is correct, you get access to the 'Adjustment mode'.

When the entered password is wrong, the following message will be displayed: 'invalid code entry'.

The projector stays in operational mode.

Remark : when no password is entered within the first minut, the projector returns automatically to operational mode.

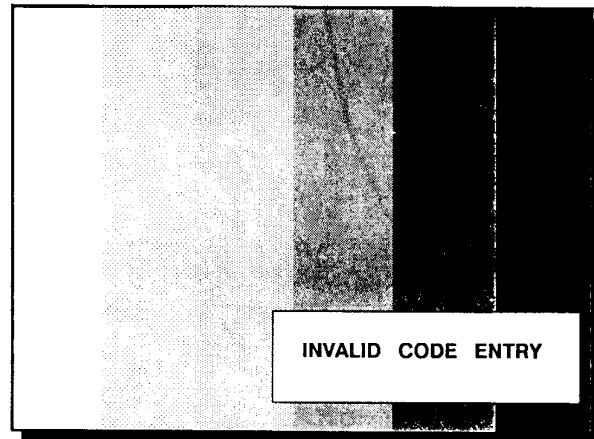
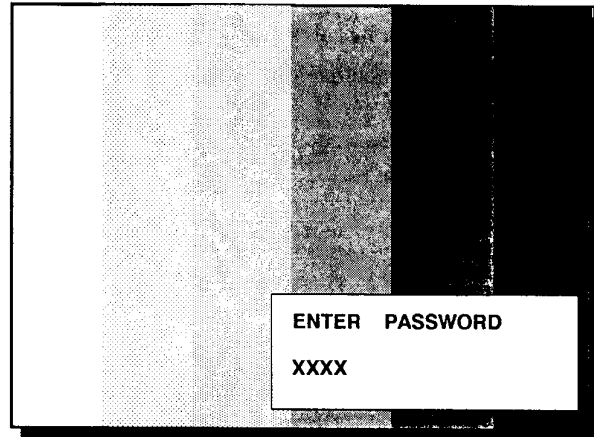

Factory programmed password :

1990

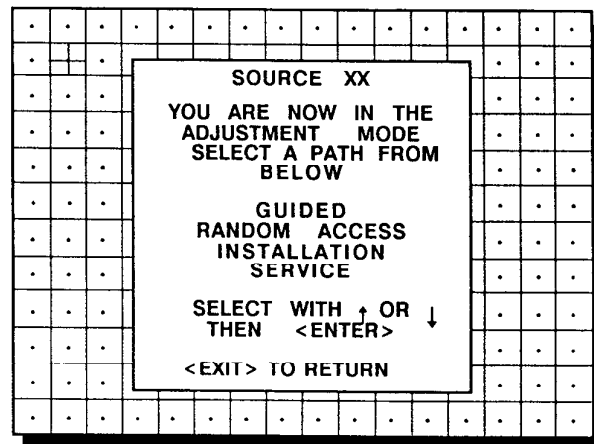

menu S1

INSTALLATION ADJUSTMENT MODE

You are now in the 'Adjustment mode'. The arrow keys are used to make menu selections and also vertical and horizontal adjustments. The **ENTER** and **EXIT** keys are used to move forward and backward through the menu structure. The **ADJUST** key can be used to terminate the adjustment mode while a selection menu (head menu) is displayed.

There are four possible paths to follow once in the Adjustment Mode. They are:

INSTALLATION - Installation should be selected if the projector has been relocated and/or a different screen size is desired. The user is instructed to make basic mechanical adjustments to the projector and may then proceed to either the Guided Adjustment Mode or the Random Access Adjustment Mode.

GUIDED - Guided should be selected if the user intends to perform a complete alignment of the projected image. All of the necessary geometry and convergence adjustments are made in a predetermined sequence.

RANDOM ACCESS - Random Access should be selected if the user intends to make only a few adjustments.

SERVICE - Service should be selected if the user intends to delete blocks, change password or apply for information.

While in Guided or Random Access adjustment Mode, the user may use an external source, an internally generated genlocked pattern or an internally generated multifrequency cross hatch pattern as a setup pattern.

When entering the installation mode, the projector will automatically switch to the internal pattern on 15 kHz/50Hz without creating a new adjustment block (more info about adjustment blocks, see appendix B).

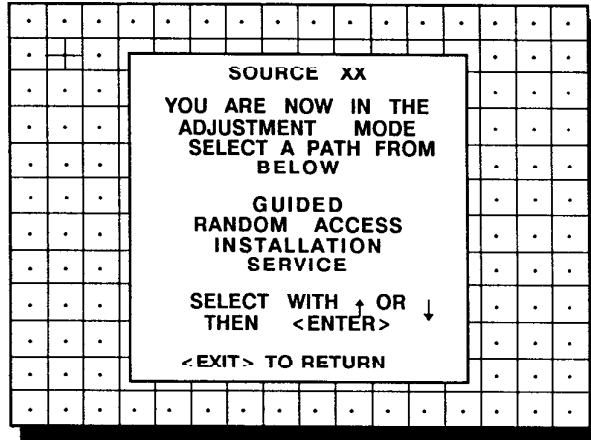

menu S1

INSTALLATION ADJUSTMENT MODE

OVERVIEW FLOW CHART INSTALLATION ADJUSTMENT MODE

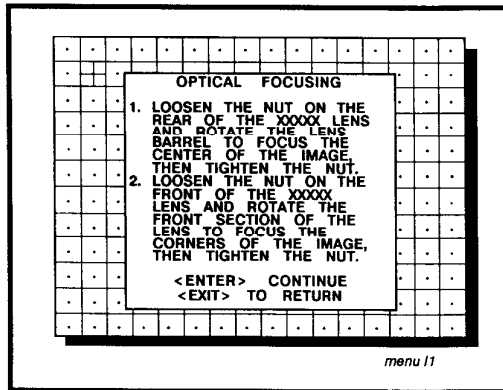

Menu 11 is repeated 3 times, first in Green, then in Red and then in Blue.

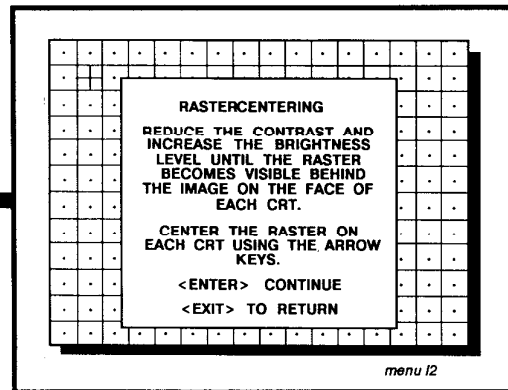

Menu 12 is displayed in green. After <ENTER> is pressed, only the green raster is displayed and

the arrow keys may be used to center the raster on the CRT surface. This menu is also displayed, once in red and once in blue.

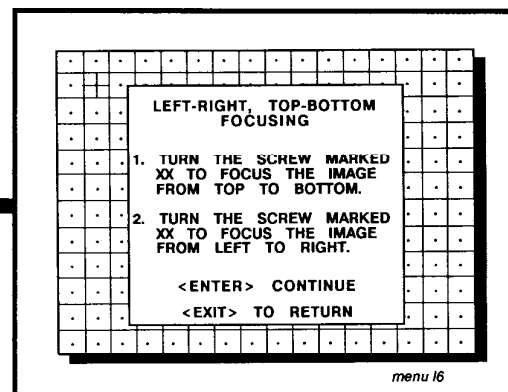
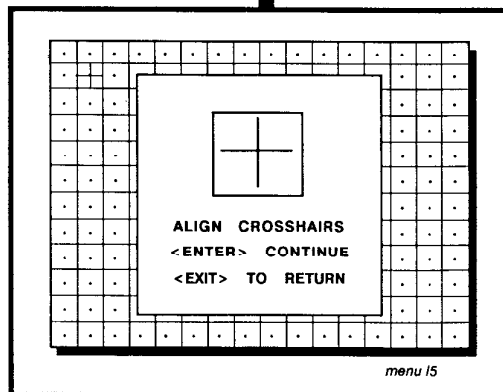
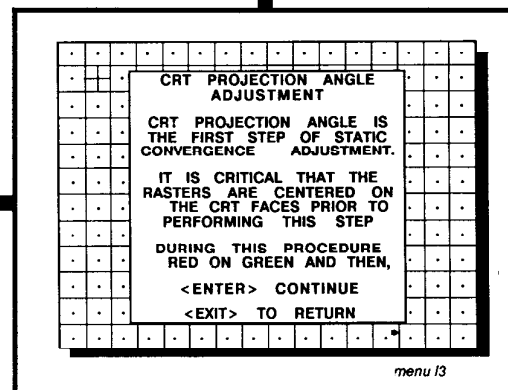
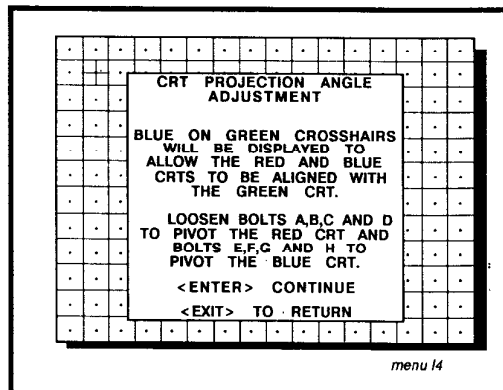

Menu 16 is repeated 2 times, first in Red and then in Blue.

INSTALLATION ADJUSTMENT MODE

INSTALLATION ADJUSTMENT MODE

It will be necessary perform several mechanical adjustments while in the Installation Adjustment Mode. Remove the small door on the lens end of the projector in order to gain access to the adjustment points.

Use the arrow keys to highlight *INSTALLATION* and then press **ENTER**.

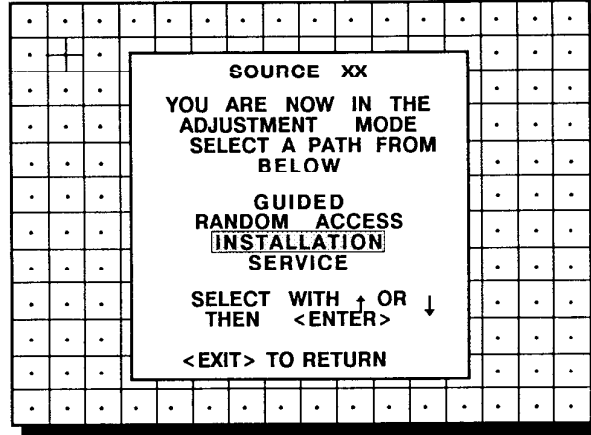

menu S1

<ENTER> continues to Optical Focusing (Menu I1)
<EXIT> returns to operational mode

INSTALLATION ADJUSTMENT MODE

Optical Lens Focusing

The optical focusing procedure is performed separately for each lens. The appropriate CRT will be switched on as the user proceeds through the optical focusing adjustment sequence.

Each lens has two focus adjustment points, one at the rear of the lens and one at the front. The center of the projected image is focused by loosening the wing nut at the rear end of the lens and rotating the lens barrel until the center of the image is clearly focused. The corners of the projected image are focused by loosening the wing nut at the front end of the lens and rotating the lens barrel until the corners of the image are clearly focused. Repetition of these adjustments may be necessary to optimize optical focusing.

Press **ENTER** key to continue.

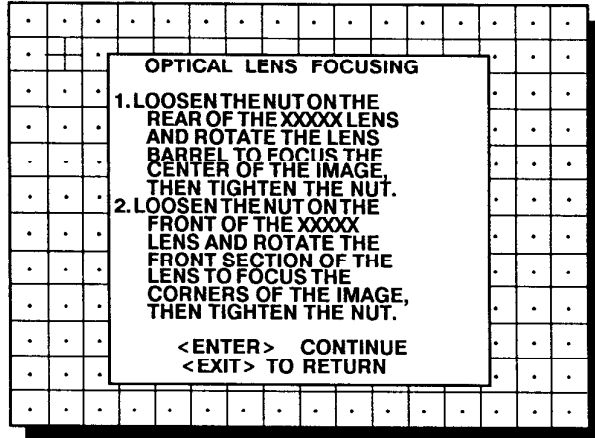

menu 11

<ENTER> continues to Raster Centering (Menu I3)
<EXIT> returns to Path Selection (Menu S1)
<ADJUST> returns to operational mode

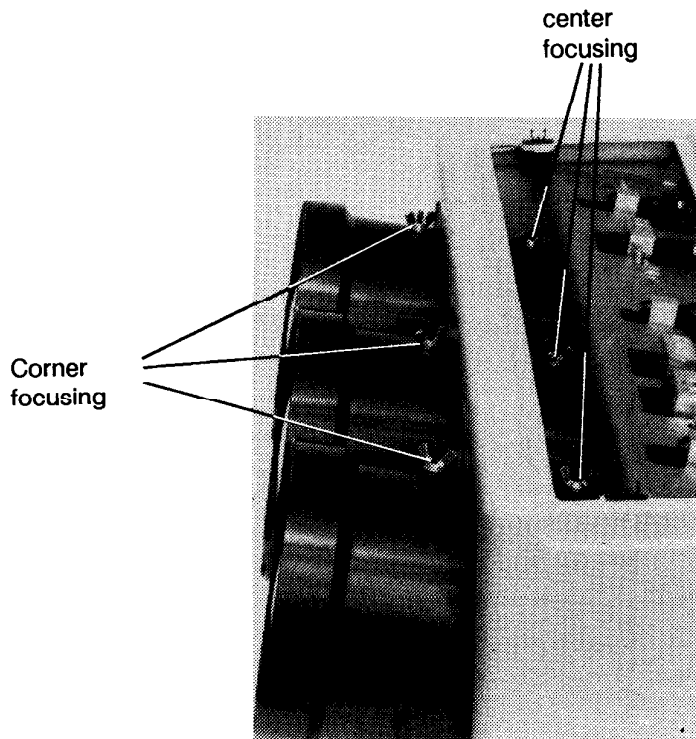

INSTALLATION ADJUSTMENT MODE

Raster centering

The raster must be centered both horizontally and vertically on the surface of each CRT, therefore, it is necessary to look into the lenses.

Caution : To avoid eye discomfort while performing these adjustments, reduce the contrast and gradually increase the brightness level until the raster becomes visible behind the image.

Press **ENTER** to display the raster on the green CRT.

Look into the green lens and shift the raster with the arrow keys until it is centered both horizontally and vertically on the surface of the CRT.

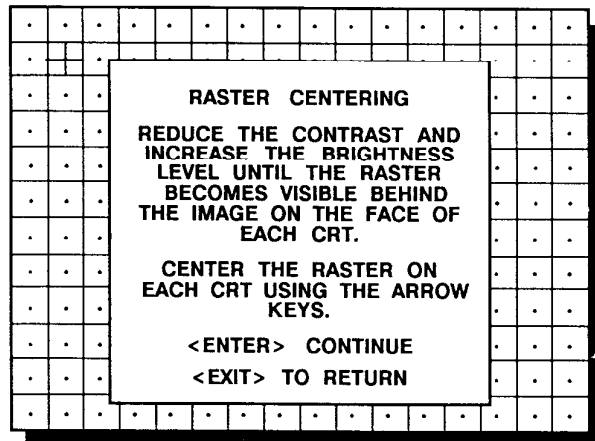

menu I2

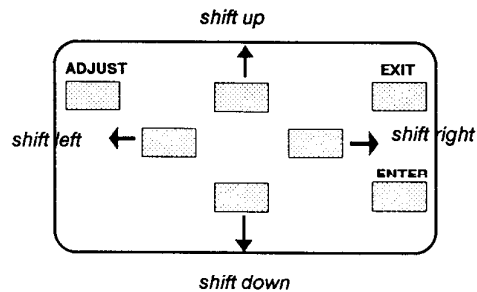
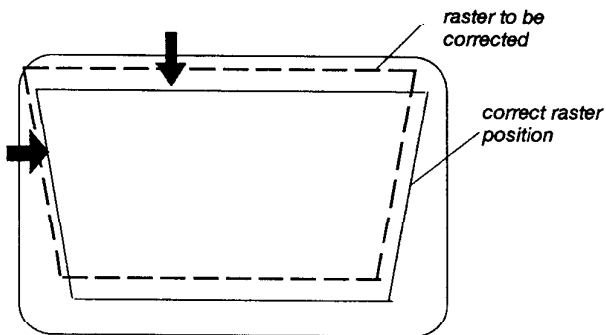

Press **ENTER** to activate the raster on the Red CRT faceplate.

Shift the red raster with the arrow keys until the raster is centered both horizontally and vertically on the surface of the CRT.

Press **ENTER** a second time to activate the raster on the Blue CRT faceplate.

Shift the blue raster with the arrow keys until the raster is centered both horizontally and vertically on the surface of the CRT.

Press **ENTER** to continue with the CRT Projection angle adjustment.

ENTER continues to CRT Projection angle Adjustment (Menu I4)
EXIT returns to Optical Focusing (Menu I2)
ADJUST returns to operational mode

INSTALLATION ADJUSTMENT MODE

CRT projection angle adjustment

The projection angle of the red and blue CRTs is dependent on the desired size of the projected image. If the centers of green, blue and red do not coincide, the CRT projection angle must be adjusted. Never try to correct this misalignment with the shift correction or the static convergence controls. These controls may only be applied to correct small errors which cannot be corrected by the CRT angle adjustment.

Be sure that the rasters are centered on the CRT face.

Press **ENTER** to start the CRT angle adjustment procedure. A crosshairs (green and red) will be displayed on the screen.

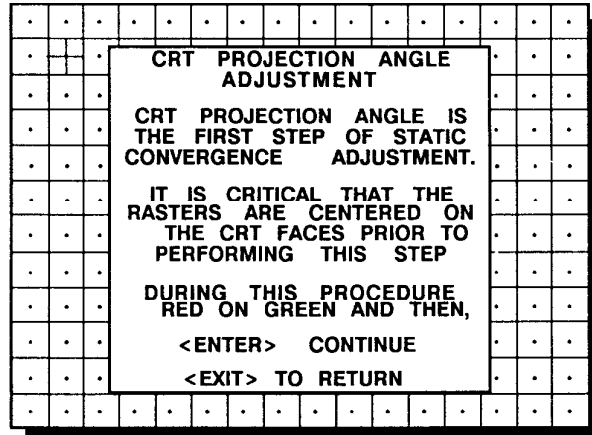

menu 13

ENTER continues to CRT Projection Angle Adjustment (Menu 14)
EXIT returns to Raster Centering (Menu 12)

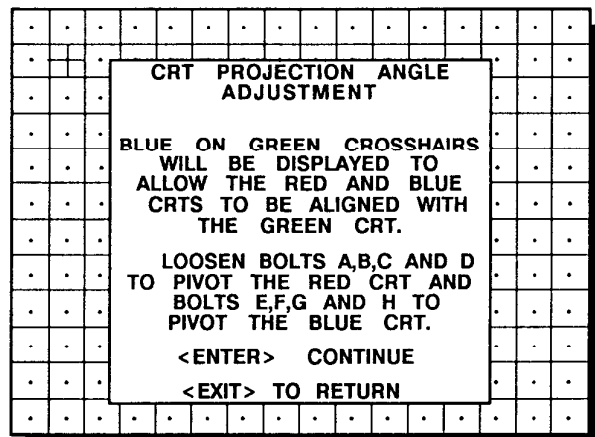
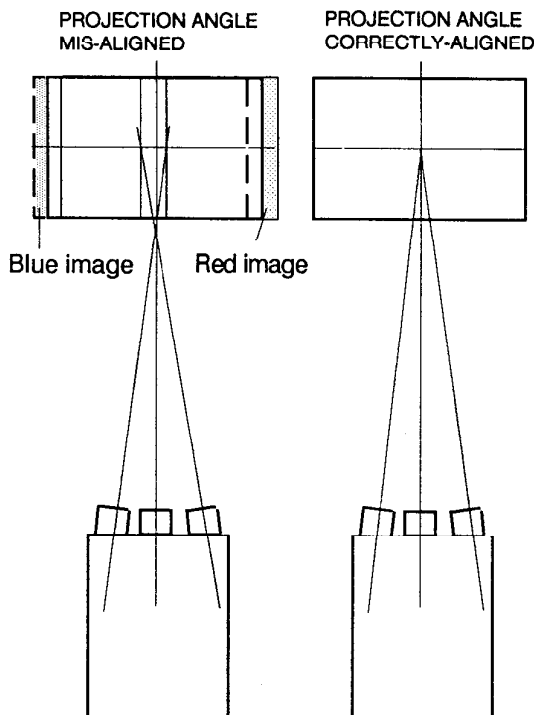

menu 14

ENTER continues to the crosshairs alignment
EXIT returns to menu 13, CRT projection angle adjustment.
ADJUST returns to operational mode

INSTALLATION ADJUSTMENT MODE

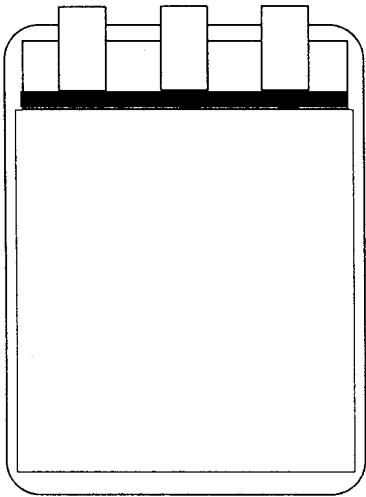

Top view mechanical assembly CRT's

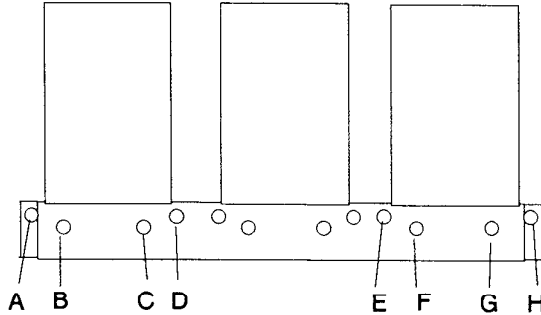

Side mechanical CRT assembly

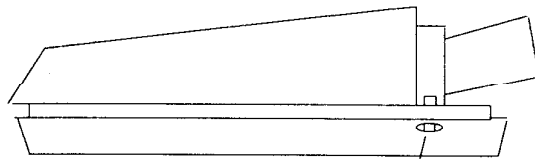

Slot in cabinet

Loosen bolt A with a 8 mm wrench through the slot in the cabinet (see side view diagram of the projector).
Loosen bolts B, C and D to pivot the red CRT until Red and Green crosshairs coincide. When the angle of the red CRT is corrected, tighten the four bolts.

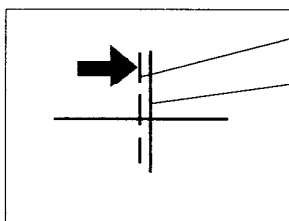

red crosshair
green crosshair

Move the Red CRT and lens assembly towards the Green CRT.

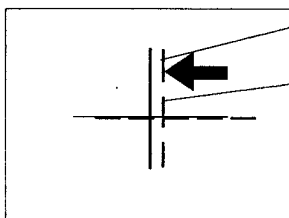

red crosshair
green crosshair
Move the Red CRT and lens assembly to the outside, away from the Green CRT.

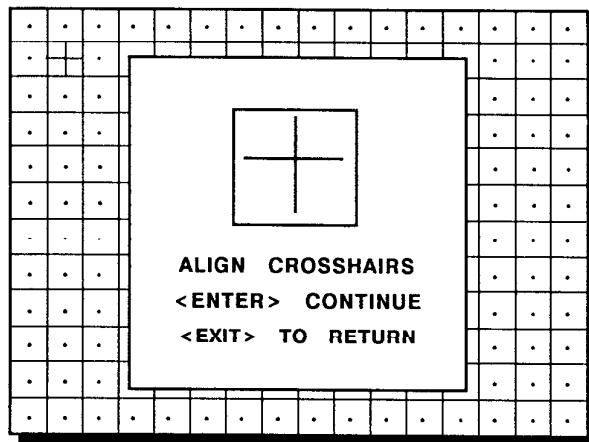

menu 15

ENTER continues to blue and green crosshairs.
EXIT will return to CRT Projection Angle Adjustment, menu 14.

INSTALLATION ADJUSTMENT MODE

Loosen bolt H with a 8 mm wrench through the slot in the cabinet (see side view diagram of the projector)

Loosen bolts E, F and G to pivot the blue CRT until the Blue and Green crosshairs coincide. When the angle of the blue CRT is corrected, tighten the four bolts.

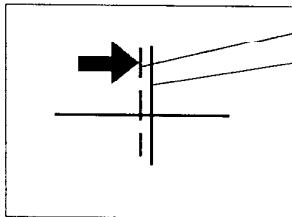

blue crosshair
green crosshair

Move the Blue CRT and lens assembly to the outside, away from the Green CRT.

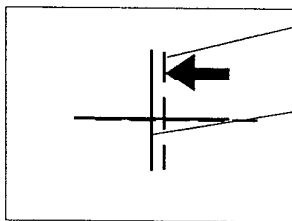

blue crosshair

green crosshair

Move the Blue CRT and lens assembly towards the Green CRT

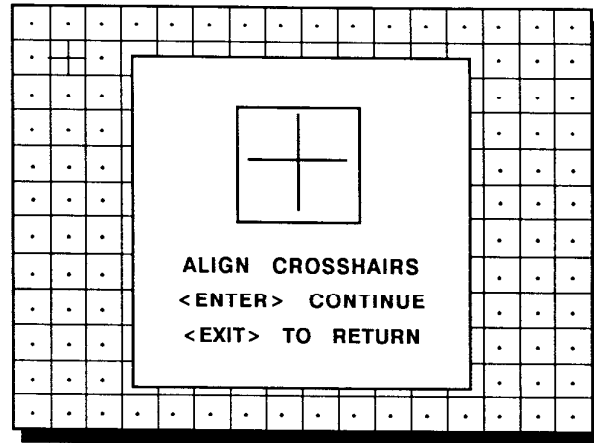

menu 15

ENTER continues with left-right, top-bottom focusing.
EXIT returns to menu 13, CRT projection angle adjustment.

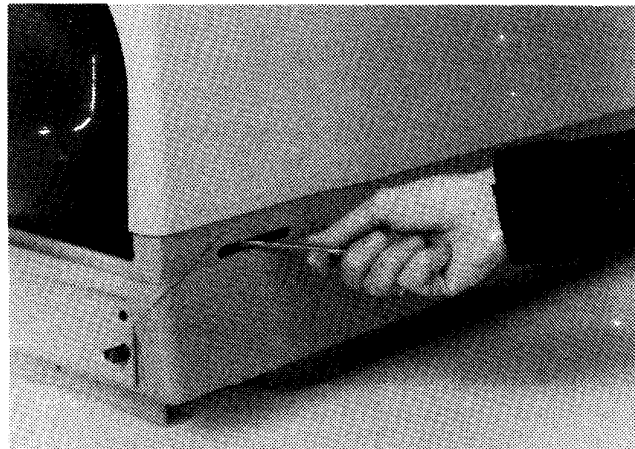

INSTALLATION ADJUSTMENTS

Diagonal image focusing

With the diagonal image focusing corrections, it is possible to obtain uniform focus for the total projected image.

These corrections must be repeated for each color. Menu I6 is repeated 3 times, first for green, then for red and then for blue.

First, be sure that the CRT projection angle is correctly adjusted, otherwise it is not possible to obtain proper overall focus of the image.

xx = screw number indication on screen.

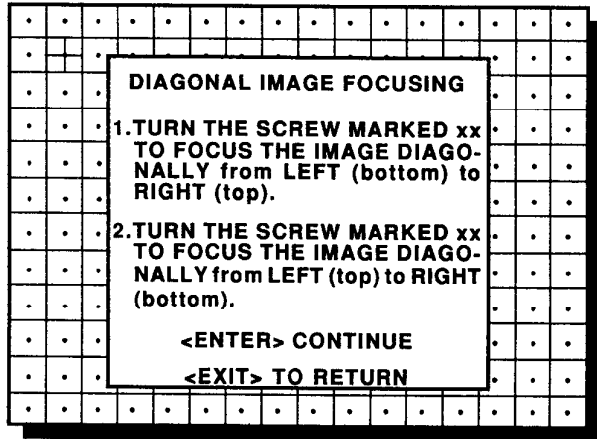

menu I6

ENTER continues to the Path Selection menu (Menu S1)
EXIT returns to CRT Projection Angle Adjustment (Menu II)
ADJUST returns to operational mode.

Adjustment procedure :

First,

To perform the diagonal image focusing, be sure the lenses are correctly focused (refer to chapter 'Optical lens focusing')

Proceed now to diagonal image focusing

This adjustment procedure is performed separately for each picture tube.

Menu I6 is repeated 3 times, first for green, then for red and then for blue.

Example: diagonal focusing the green image

- Equalize diagonally the focus from left (bottom) to right (top) by turning screw 00 of the projected color.

- Equalize now diagonally the focus from left (top) to right (bottom) by turning screw 01 of the projected color.

Repeat the same procedure for the red and blue image using the corresponding screws.

To optimize the image focusing, repeat the optical lens focusing.

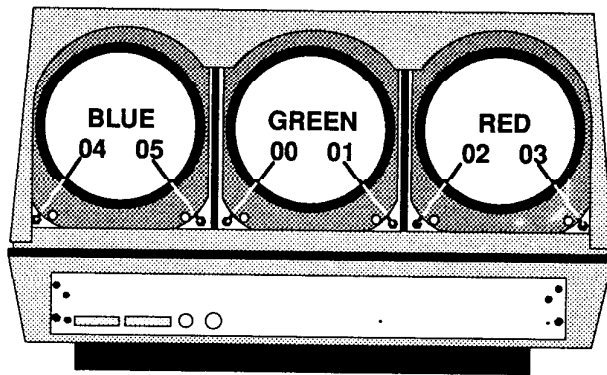

Screw indication on screen :

	left	right
GREEN	00	01
RED	02	03
BLUE	04	05

INSTALLATION ADJUSTMENTS

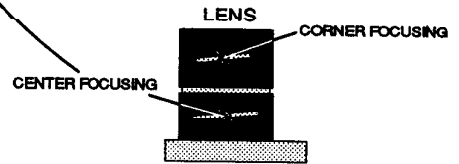
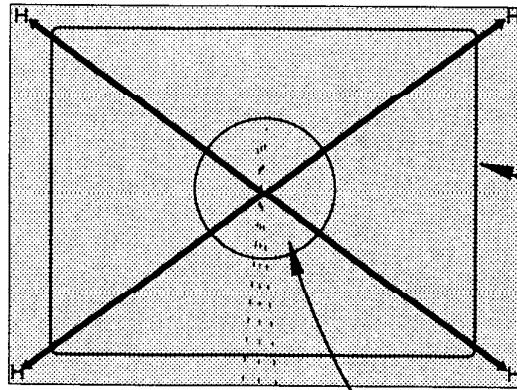

DIAGONAL IMAGE FOCUSING

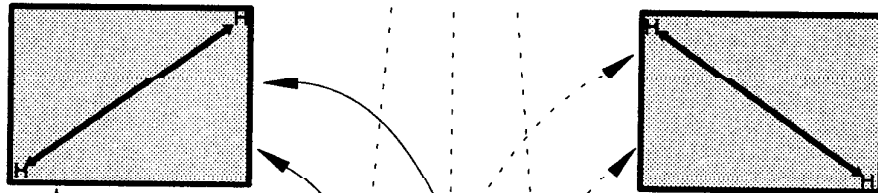

RED IMAGE
03 02

BLUE IMAGE
05 04

GREEN IMAGE
01 00

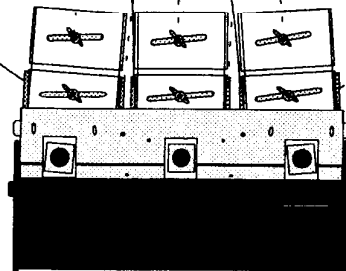

GUIDED ADJUSTMENT MODE

GUIDED ADJUSTMENT MODE

GUIDED ADJUSTMENT MODE

Start up of the guided adjustment mode.

Use the arrow keys to highlight *GUIDED* on menu S1 and then press **ENTER**.

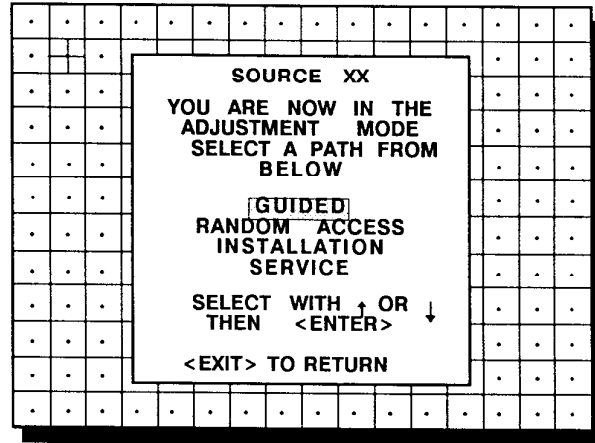

menu S1

<ENTER> continues to Setup Pattern Selection
(Menu S2 or S3)
<EXIT> returns to operational mode.

GUIDED ADJUSTMENT MODE

Overview flow chart 'Guided Adjustment' procedure

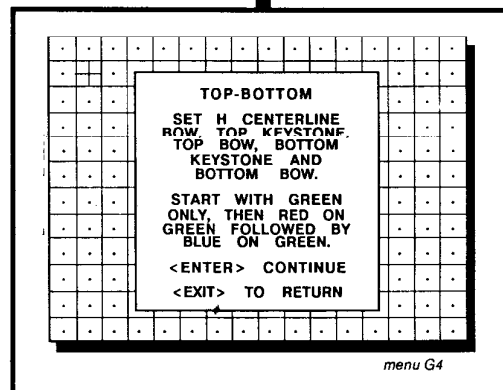
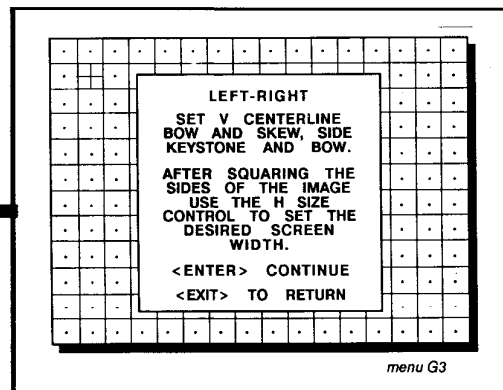
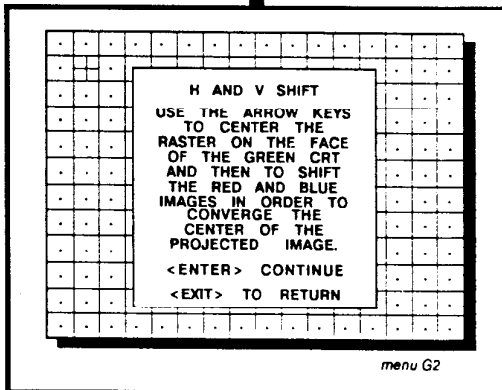
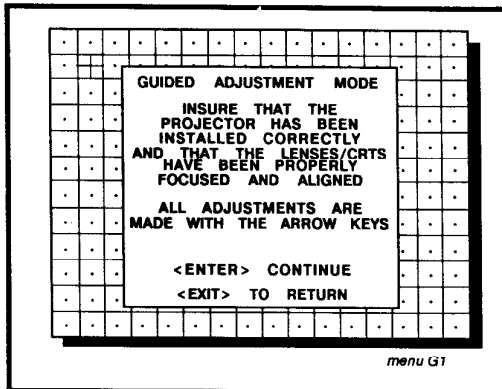

GUIDED ADJUSTMENT MODE

SIZE-LINEARITY
ADJUST THE H SIZE,
V LINEARITY AND
V SIZE IN ORDER TO
SET THE DESIRED
IMAGE DIMENSIONS

USE THE H PHASE
CONTROL TO SHIFT
THE IMAGE WITH
RESPECT TO THE
RASTER

<ENTER> CONTINUE
<EXIT> TO RETURN

menu G5

CONVERGENCE
START WITH RED ON GREEN,
THEN BLUE ON GREEN. USE
THE ARROW KEYS TO MAKE
HORIZONTAL AND VERTICAL
CONVERGENCE ADJUSTMENTS
IN THE AREA INDICATED BY
THE BOX. <ENTER> WILL
MOVE THE BOX TO THE NEXT
AREA TO BE CONVERGED AND
<EXIT> WILL MOVE IT BACK
TO THE LAST AREA.

<ENTER> CONTINUE
<EXIT> TO RETURN

menu G6

BLANKING
ADJUST THE TOP,
BOTTOM, LEFT AND
RIGHT BLANKING
IN ORDER TO FRAME
THE PROJECTED
IMAGE ON TO THE
SCREEN.
THIS PROCEDURE
WILL CONCLUDE THE
GUIDED ADJUSTMENT
SEQUENCE.

<ENTER> CONTINUE
<EXIT> TO RETURN

menu G7

GUIDED ADJUSTMENT MODE

Selecting Setup Pattern

If an external source is connected to the projector, Menu S2 will be displayed. Use the arrow keys to highlight the desired setup pattern and then press **ENTER**.

Genlocked pattern : internally generated cross hatch pattern, locked on the external source.

Internal # pattern : internally generated cross hatch pattern and locked on internal generated sync signals. (No external source necessary)

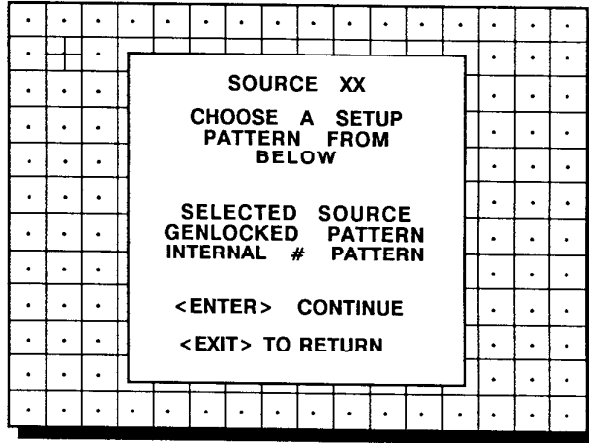

menu S2

<ENTER> continues to Guided Adjustment Mode (Menu G1) or Internal # Pattern Selection (Menu S4)
<EXIT> returns to Path Selection (Menu S1)
<ADJUST> returns to operational mode

If no external source is connected to the projector, Menu S3 will be displayed. Press **ENTER** to select the internally generated cross hatch pattern.

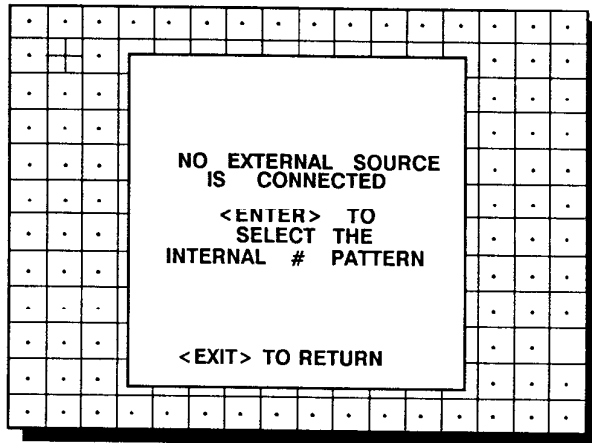

menu S3

<ENTER> continues to Internal # Pattern Selection (Menu S4)
<EXIT> returns to Path Selection (Menu S1)

GUIDED ADJUSTMENT MODE

Internal Cross Hatch Pattern

Menu S4 will be displayed if the internal cross hatch pattern has been selected. The table below lists the 8 factory preset frequencies available.

Use the arrow keys to highlight the desired cross hatch frequency and then press **ENTER**.

- STD: Fh = 15.6 KHz Fv = 50 Hz
- CGA: Fh = 15.7 KHz Fv = 60 Hz
- EGA: Fh = 21.9 KHz Fv = 60 Hz
- VGA: Fh = 31.5 KHz Fv = 60 Hz
- PR1: Fh = 35.0 KHz Fv = 60 Hz
- PR2: Fh = 48.0 KHz Fv = 60 Hz
- PR3: Fh = 64.0 KHz Fv = 60 Hz
- PR4: Fh = 90.0 KHz Fv = 60 Hz

It is possible to store user defined cross hatch frequencies in PR1 - PR4. Follow the steps below to program a custom cross hatch frequency.

1. Highlight the desired storage location (PR1 - PR4) on menu S4.
2. Press **TEXT** to reprogram.
3. Use the arrow keys to select the digits to be changed..
4. Reprogram the desired horizontal frequency as XX.X kHz and the vertical frequency as XXX Hz using the numeric keys.
5. Press **ENTER** to confirm.

Example: Desired cross hatch frequency:

Fh = 34.8 KHz
Fv = 60 Hz

Use the arrow keys to highlight the desired storage location (PR1-PR4) and press **TEXT**. The reprogram menu appears on the screen. Use the arrow keys to go to the first digit of the horizontal frequency and press

3 4 8 0 6 0 <ENTER>

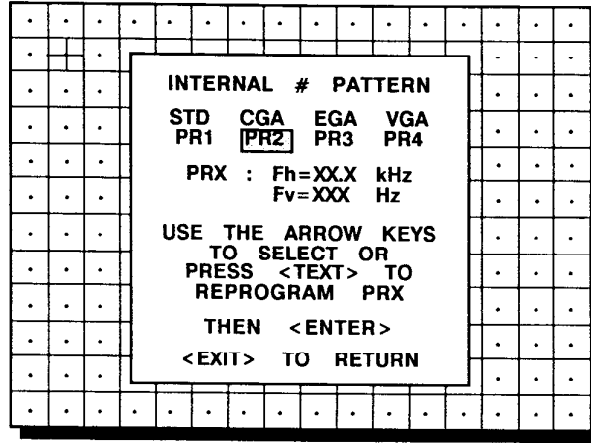

<ENTER> continues to Guided Adjustment Mode (Menu G1)
<EXIT> returns to Setup Pattern Selection (Menu S2 or S3)
<TEXT> gives the reprogram menu (Menu S4bis)

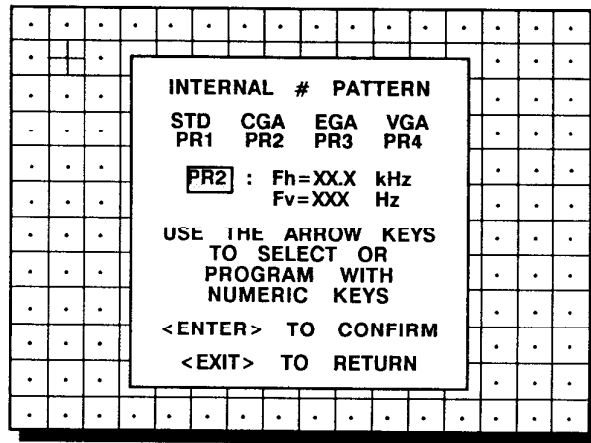

<ENTER> confirms your entry and continues to Guided Adjustment mode (Menu G1)
<EXIT> returns to Setup Pattern Selection (Menu S2 or S3)

GUIDED ADJUSTMENT MODE

Note: Before continuing, insure that the lenses are properly focused and that the CRT projection angle is correctly adjusted.

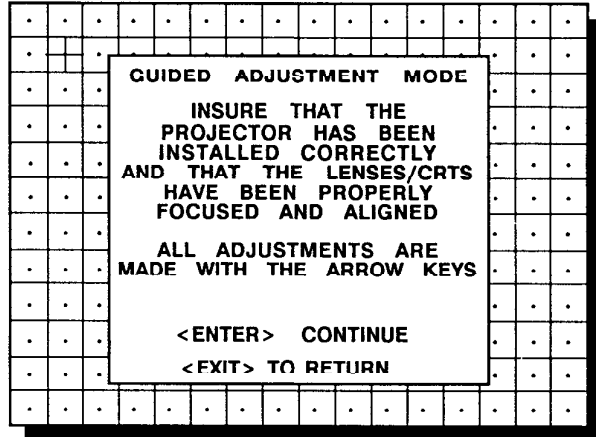

menu G1

<ENTER> continues to Horizontal and Vertical Shift (Menu G2)
<EXIT> returns to Setup Pattern Selection (Menu S2) or Internal # Pattern Selection (Menu S4)
<ADJUST> returns to operational mode

GUIDED ADJUSTMENT MODE

Raster Centering on Green CRT Faceplate

The green raster must be centered both horizontally and vertically on the center of the CRT surface. To center the green raster, look into the green lens and use the arrow keys to move the raster.

CAUTION

It is necessary to look into the lenses to perform the following adjustments. To avoid eye discomfort while looking into the lenses, reduce the contrast and gradually increase the brightness level until the raster becomes visible.

To begin the adjustment, press the **ENTER** key.

H AND V SHIFT
USE THE ARROW KEYS
TO CENTER THE
RASTER ON THE FACE
OF THE GREEN CRT
AND THEN TO SHIFT
THE RED AND BLUE
IMAGES IN ORDER TO
CONVERGE THE
CENTER OF THE
PROJECTED IMAGE.
<ENTER> CONTINUE
<EXIT> TO RETURN

menu G2

<ENTER> continues to Green Raster Shift
 <EXIT> returns to Guided Adjustment Mode (Menu G1)
 <ADJUST> returns to operational mode

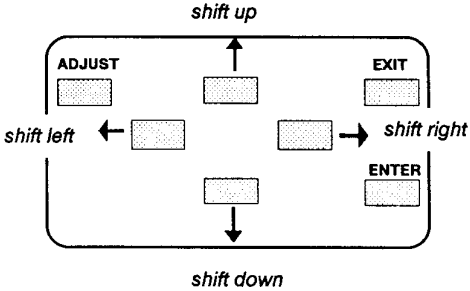
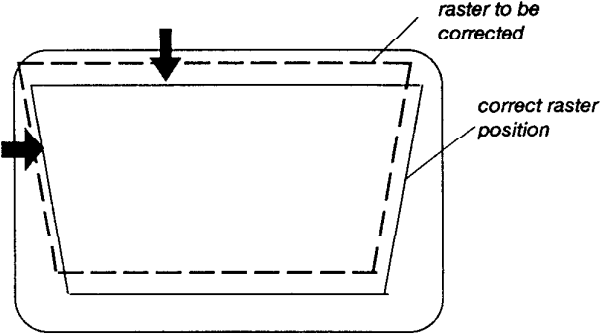

After centering the green raster, press the **ENTER** key to continue.

<ENTER> continues to Red Raster Shift
 <EXIT> returns to Horizontal and Vertical Shift (Menu G2)

GUIDED ADJUSTMENT MODE

Shifting Red and Blue on Green

Use the arrow keys to shift the red image until the center of the projected image is converged.

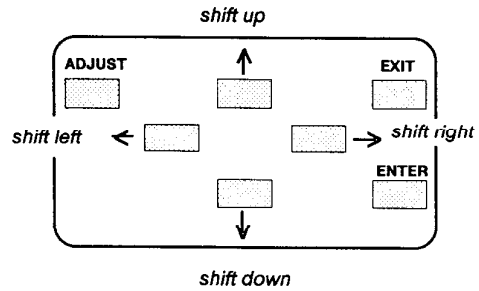
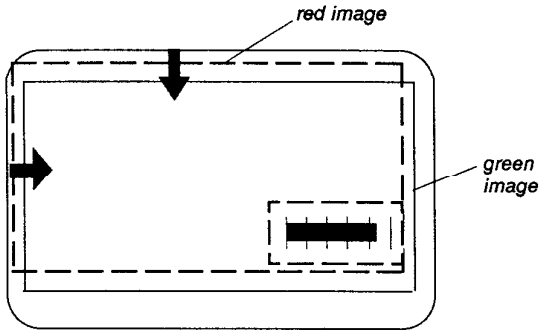

When the red image is correctly positioned, press the **ENTER** key to continue.

<ENTER> continues to blue raster shift
<EXIT> returns to green raster shift

Use the arrow keys to shift the blue image until the center of the projected image is converged.

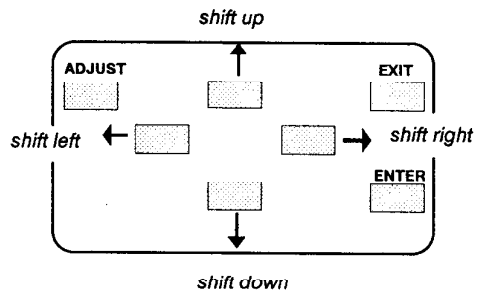
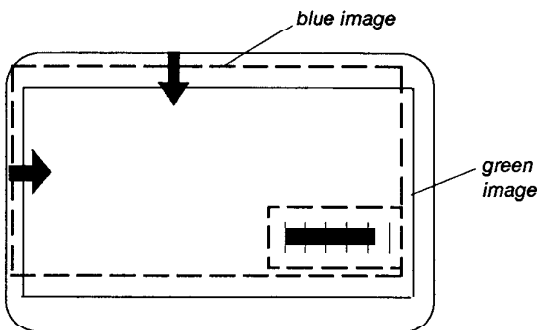

When the blue image is correctly positioned, press the **ENTER** key to continue.

<ENTER> continues to Left-Right adjustments (Menu G3)
<EXIT> returns to red raster shift

GUIDED ADJUSTMENT MODE

Left-Right (East-West) Adjustments

Left-right adjustments affect only the vertical lines of the setup pattern. Only the green image is displayed while making left-right adjustments. The red and blue images will automatically be corrected in the same manner.

Convergence corrections are automatically disabled for the duration of these adjustments.

Press the **ENTER** key to continue.

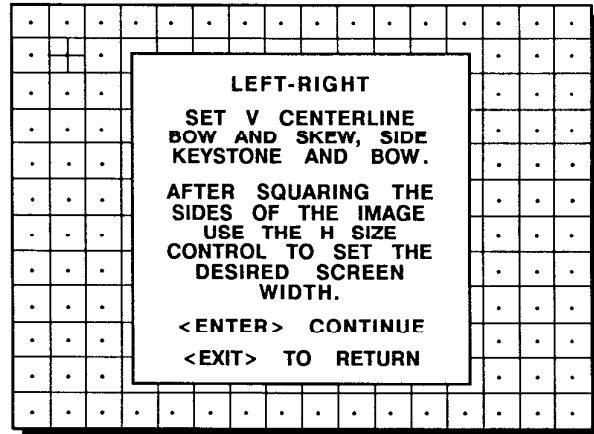

menu G3

<ENTER> continues to vertical centerline bow adjustment
 <EXIT> returns to Horizontal and Vertical Shift (Menu G2)
 <ADJUST> returns to operational mode

Vertical Centerline Bow Adjustment

Use the left or right arrow key to adjust the vertical centerline bow of the setup pattern and then press the **ENTER** key to continue.

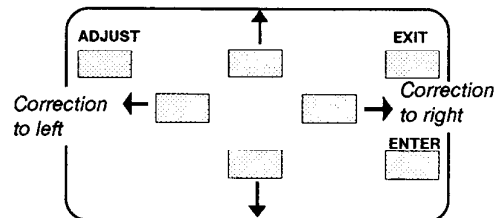
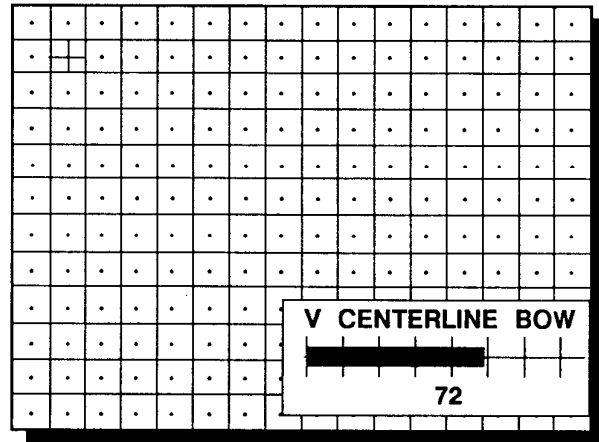
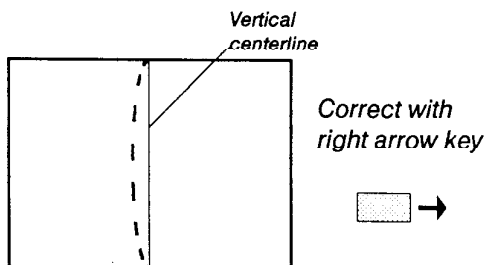
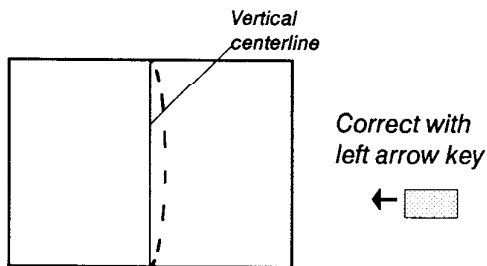

<ENTER> continues to vertical centerline skew adjustment
 <EXIT> returns to Left-Right adjustments (Menu G3)

GUIDED ADJUSTMENT MODE

Vertical Centerline Skew Adjustment

Use the left or right arrow key to adjust the vertical centerline skew of the setup pattern until this line is straight. Misalignment of the outer vertical lines will be corrected with the bow and keystone corrections. Press **ENTER** to continue.

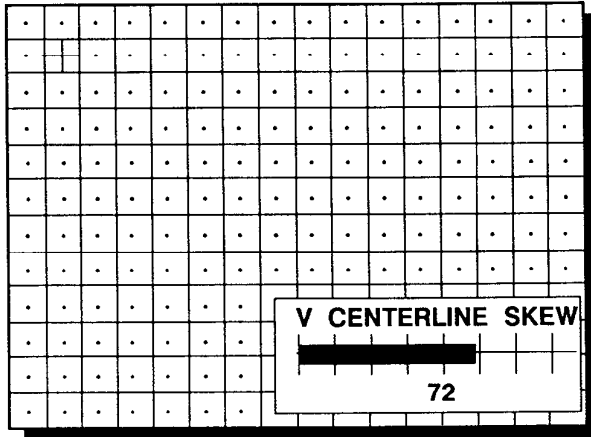

Vertical centerline

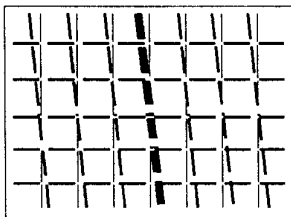

Correct with right arrow key



Vertical centerline

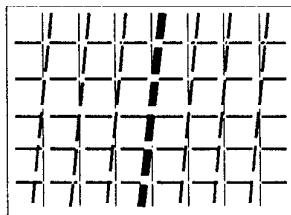

Correct with left arrow key

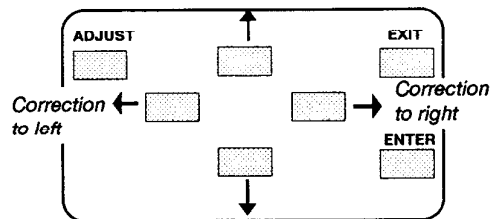

<ENTER> continues to side keystone adjustment
<EXIT> returns to vertical centerline bow adjustment

GUIDED ADJUSTMENT MODE

Side Keystone Adjustment

Use the left or right arrow key to adjust the side keystone (vertical lines) of the setup pattern and press **ENTER** to continue

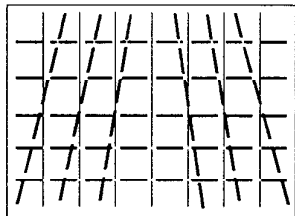
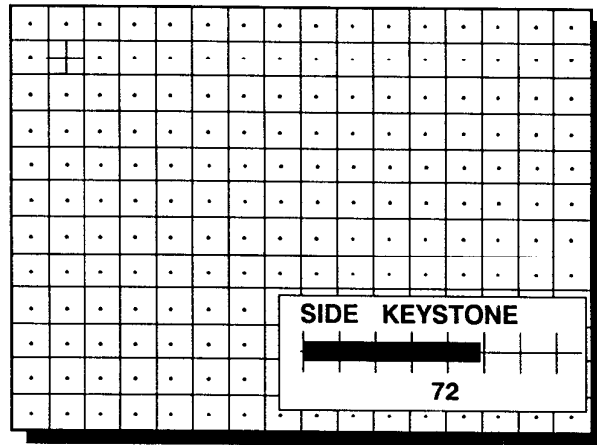

Correct with
right arrow key

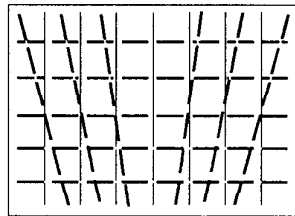
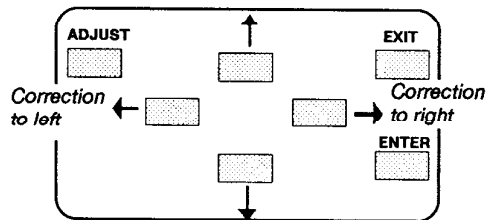

Correct with
left arrow key



<ENTER> continues to side bow adjustment
<EXIT> returns to vertical centerline skew adjustment

GUIDED ADJUSTMENT MODE

Side Bow Adjustment

Use the left or right arrow key to adjust the side bow of the setup pattern (vertical lines) and press **ENTER** to continue.

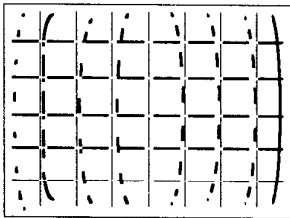
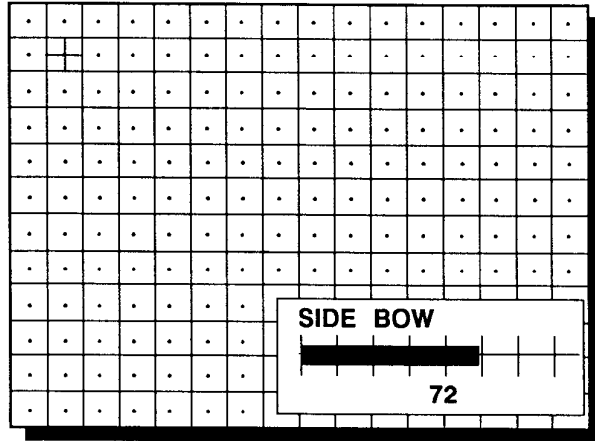

Correct with
right arrow key

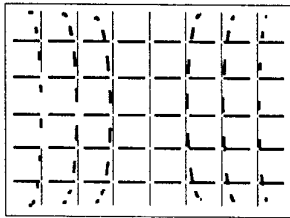

Correct with
left arrow key

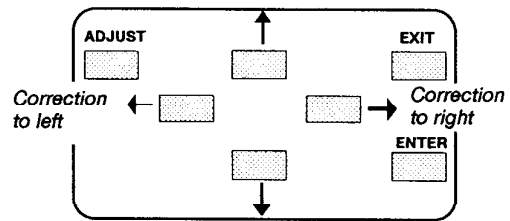

<ENTER> continues to horizontal size adjustment
<EXIT> returns to side keystone adjustment

GUIDED ADJUSTMENT MODE

Horizontal Size Adjustment

Adjust the horizontal size with the left and right arrow key until the exact image width is obtained.

Therefore :

- if the internal # pattern was selected, this pattern remains on the screen.
- if the genlocked pattern was selected, the external source will be displayed.

Hint :

In order to avoid loss of resolution in the projected image and to ensure maximum CRT longevity, do not use an excessively small horizontal size setting.

A bar scale and a number indicator (between 0 and 100) give a visual indication of the horizontal size adjustment.

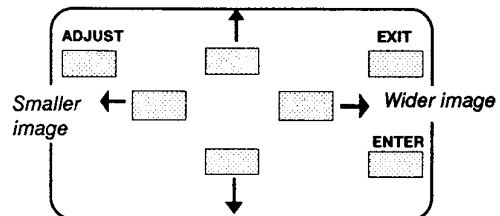
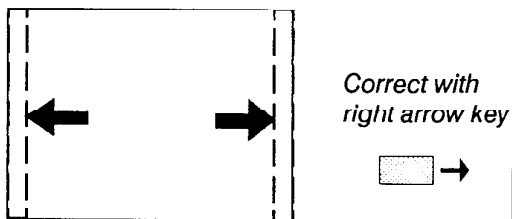
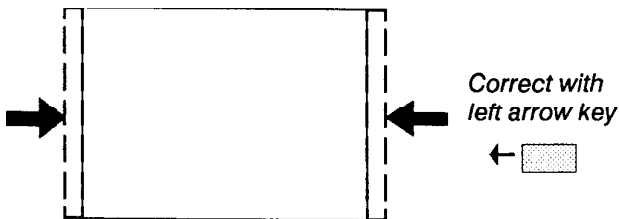
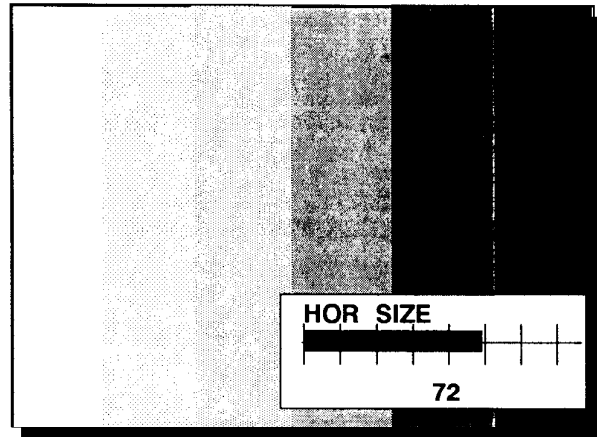

<ENTER> continues to Top-Bottom adjustments (Menu G4)
<EXIT> returns to side bow adjustments

GUIDED ADJUSTMENT MODE

Top-Bottom (North-South) Adjustments

Top-Bottom adjustments affect only the horizontal lines of the setup pattern. These adjustments are performed on the green image first. The adjustment sequence is then repeated for the red image while superimposed on the green image and then the blue image while superimposed on the green image.

Convergence corrections are automatically disabled for the duration of these adjustments.

Press the **ENTER** key to continue.

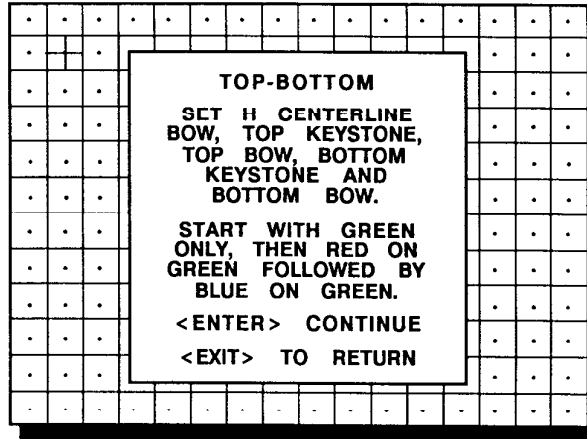

menu G4

<ENTER> continues to horizontal centerline bow adjustment
<EXIT> returns to Left-Right adjustments (Menu G3)
<ADJUST> returns to operational mode

GUIDED ADJUSTMENT MODE

Horizontal Centerline Bow Adjustment

Use the up and down arrow key to adjust the horizontal centerline bow of the setup pattern.

A bar scale and a numeric indicator (between 0 and 100) will give a visual indication of the bow correction.

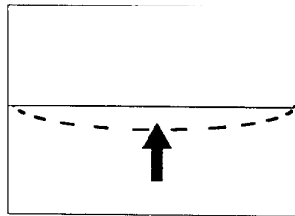
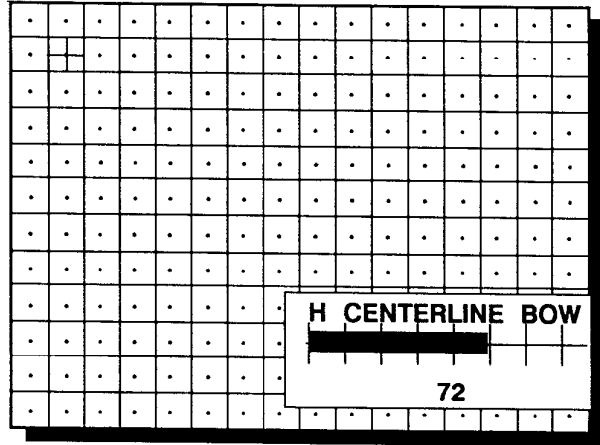

Correct with up arrow key

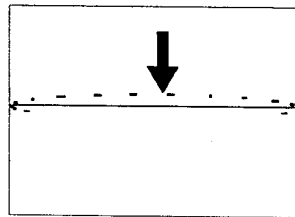

Correct with down arrow key

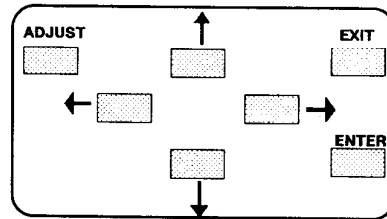

<ENTER> continues to top keystone adjustment
 <EXIT> returns to Top-Bottom Adjustments (Menu G4)

GUIDED ADJUSTMENT MODE

Top Keystone Adjustment

Adjust the horizontal lines in the upper part of the picture with the arrow keys until these lines are straight, or almost straight. Press **ENTER** to continue. A bar scale and a number indicator (between 0 and 100) will give a visual indication of the bow correction.

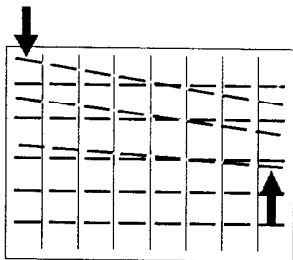
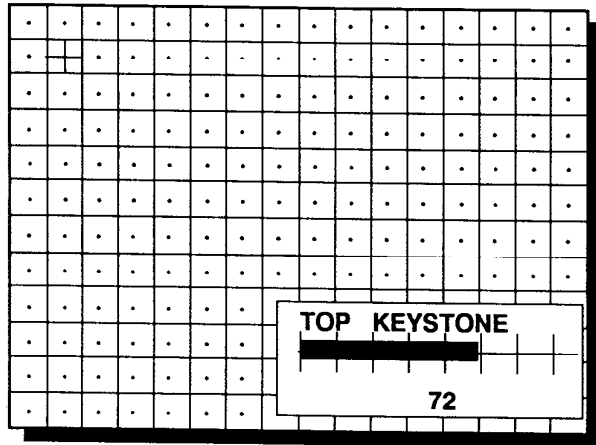

Correct with up arrow key

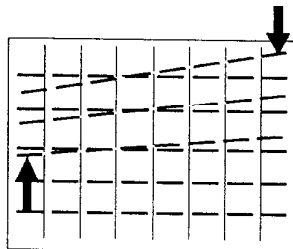

Correct with up arrow key

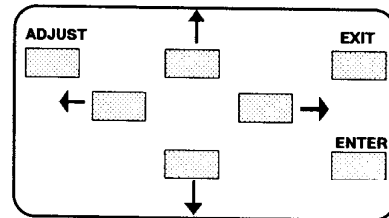

<ENTER> continues to top bow adjustment
 <EXIT> returns to horizontal centerline bow adjustment

GUIDED ADJUSTMENT MODE

Top Bow Adjustment

Adjust the bow of the horizontal lines in the upper side of the image with the arrow keys until these lines are straight. A bar scale and a number indicator below indicate the amount of adjustment.

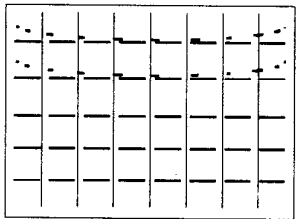
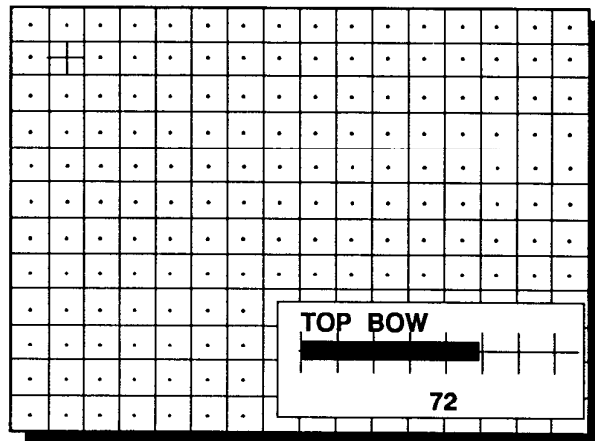

Correct with
down arrow key

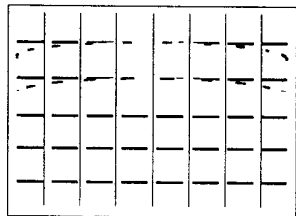

Correct with up
arrow key

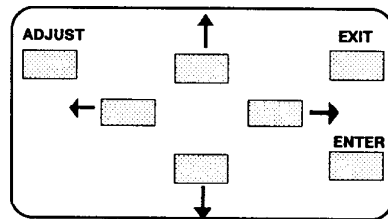

<ENTER> continues to bottom keystone adjustment
<EXIT> returns to top keystone adjustment

GUIDED ADJUSTMENT MODE

Bottom Keystone Adjustment

Adjust the horizontal lines in the lower part of the image with the arrow keys until these lines are straight.

A bar scale and a number indicator will give a visual indication of the adjustment.

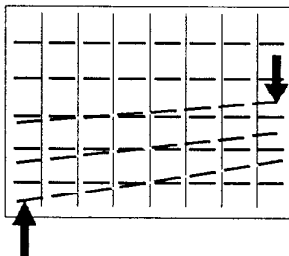
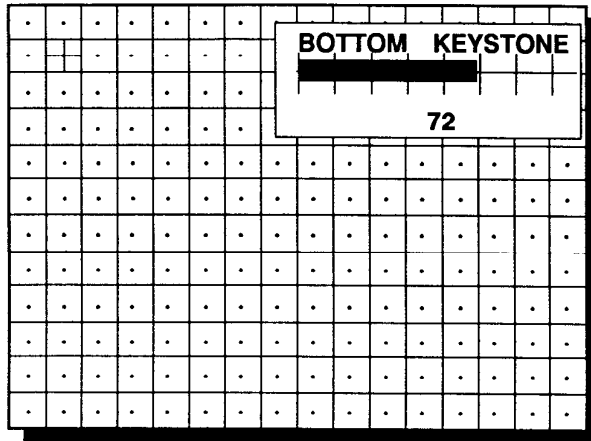

Correct with
down arrow key

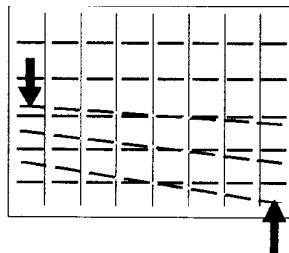

Correct with up
arrow key

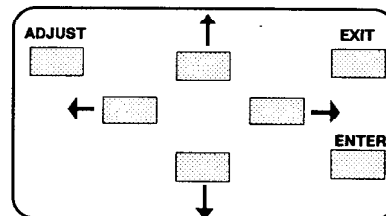

<ENTER> continues to bottom bow adjustment
<EXIT> returns to top bow adjustment

GUIDED ADJUSTMENT MODE

Bottom Bow Adjustment

Use the top and bottom arrow key to adjust the bottom bow in the lower part of the setup pattern. Adjust until the horizontal lines are straight.

A bar scale and a number indicator (between 0 and 100 %) give a visual indication of the adjustment.

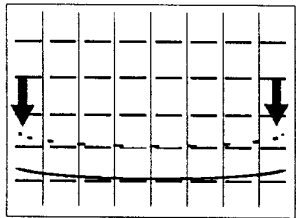
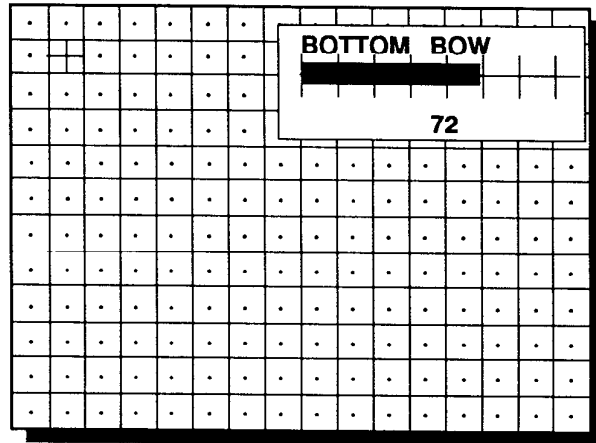

Correct with
down arrow key

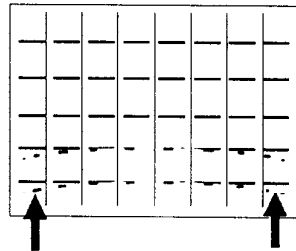

Correct with up
arrow key

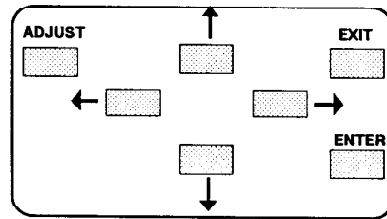

<ENTER> continues to Size-Linearity (Menu G5)
<EXIT> returns to bottom keystone adjustment

GUIDED ADJUSTMENT MODE

Size-linearity Adjustment

Size adjustments affect the height and width of the projected image. The vertical linearity adjustment is used to adjust the horizontal lines of the setup pattern until the spacing between them is even. The horizontal phase adjustment is used to shift the image horizontally across the raster.

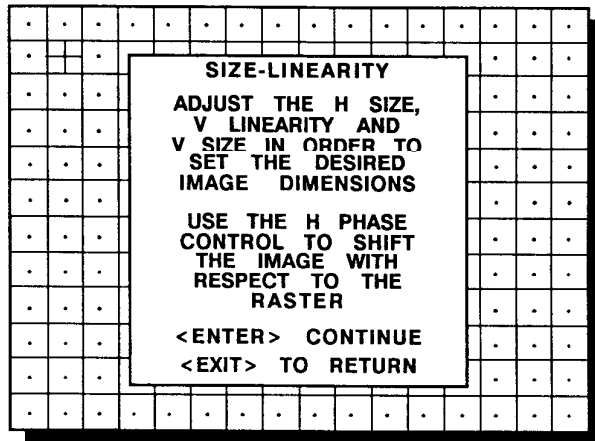

<ENTER> continues to horizontal size adjustment
<EXIT> returns to Top-Bottom adjustments (Menu G4)
<ADJUST> returns to operational mode

GUIDED ADJUSTMENT MODE

Horizontal Size Adjustment

Adjust the horizontal size with the left and right arrow key until the exact image width is obtained.

Therefore :

- if the internal # pattern was selected, this pattern remains on the screen.
- if the genlocked pattern was selected, the external source will be displayed.

Hint :

In order to avoid loss of resolution in the projected image and to ensure maximum CRT longevity, do not use an excessively small horizontal size setting.

A bar scale and a number indicator (between 0 and 100) give a visual indication of the horizontal size adjustment.

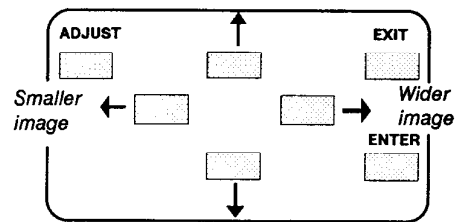
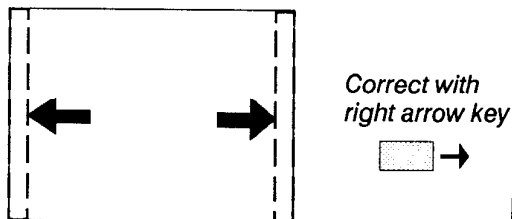
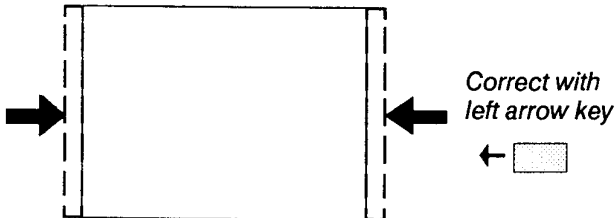
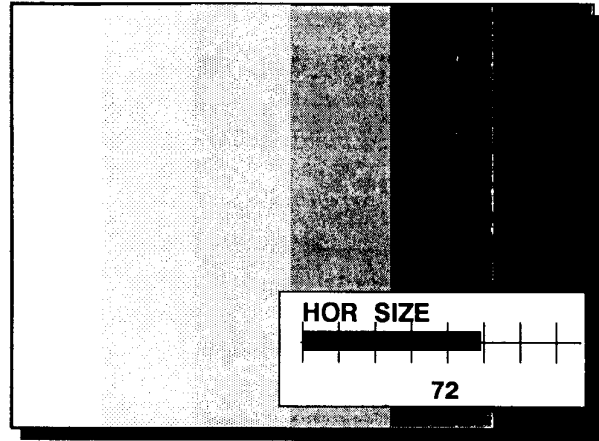

<ENTER> continues to vertical linearity adjustment
<EXIT> returns to Size-Linearity (Menu G5)

GUIDED ADJUSTMENT MODE

Vertical Linearity Adjustment

Adjust the vertical linearity with the arrow keys until the distance between the horizontal lines of the set up pattern are equal.

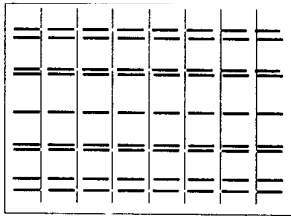
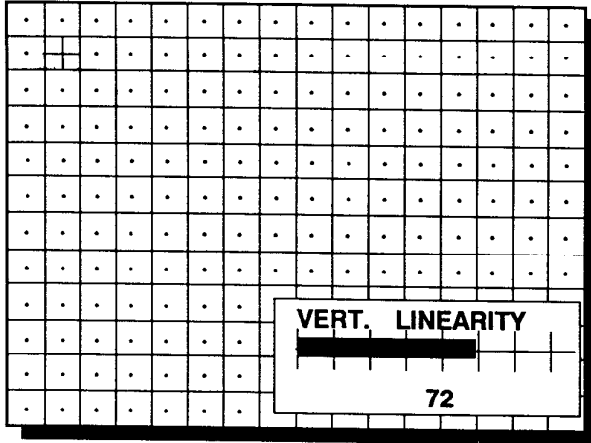

Correct with up arrow key



Correct with down arrow key

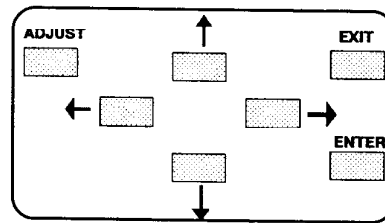

<ENTER> continues to vertical size adjustment
<EXIT> returns to horizontal size adjustment

GUIDED ADJUSTMENT MODE

Vertical Size Adjustment

Adjust the vertical size with the up or down arrow key until the exact image height is obtained.

Therefore :

- if the internal # pattern was selected, this pattern remains on the screen.
- if the genlocked pattern was selected, the external source will be displayed.

Hint :

In order to avoid loss of resolution in the projected image and to ensure maximum CRT longevity, do not use an excessively small vertical size setting.

A bar scale and a number indicator (between 0 and 100) give a visual indication of the vertical size adjustment.

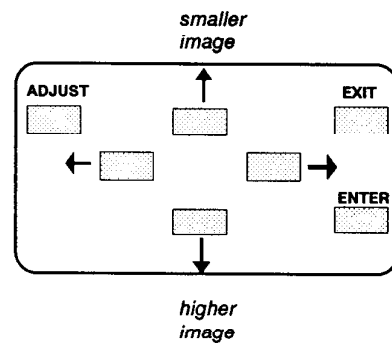
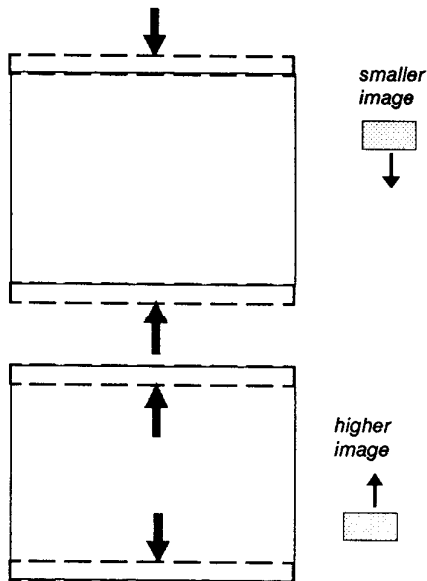
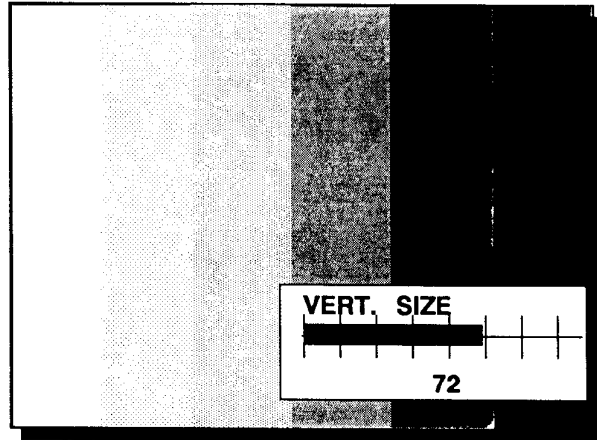

<ENTER> continues to horizontal phase adjustment
<EXIT> returns to vertical linearity adjustment

GUIDED ADJUSTMENT MODE

Horizontal Phase Adjustment

Adjust the horizontal phase with the arrow keys until full characters are displayed on the left and right side of the picture.

Therefore :

- if the internal # pattern was selected, this pattern remains on the screen.
- if the genlocked pattern was selected, the external source will be displayed.

In order to optimize the image quality, the image should be shifted to the 'end of scan' side of the raster. For front screen applications, the 'end of scan' side of the raster is on the right hand side of the screen. For rear screen applications, it is on the left hand side.

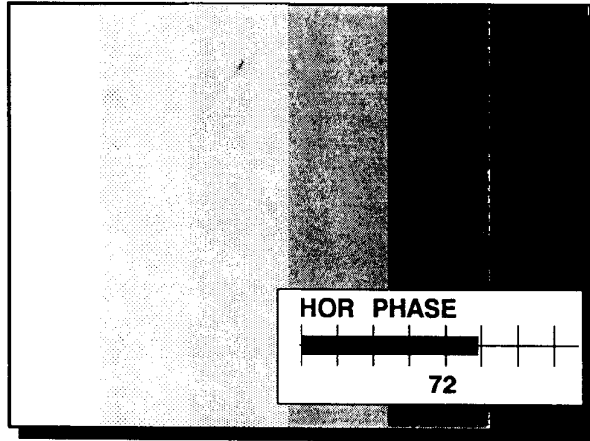

Decrease the contrast and increase the brightness level until the raster becomes visible on the screen. Use the left or right arrow keys to shift the setup pattern to the proper position on the raster.

Restore the brightness and contrast to normal levels after performing the horizontal phase adjustment.

A bar scale and a number indicator (between 0 and 100) on the screen give a visual indication of the horizontal phase adjustment.



Correct with
right arrow key



Correct with
left arrow key

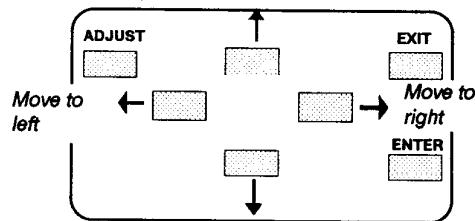

<ENTER> continues to Convergence (Menu G6)
<EXIT> returns to vertical size adjustment

GUIDED ADJUSTMENT MODE

Convergence Adjustment

Convergence adjustments affect both the horizontal and vertical lines of the setup pattern. These adjustments are performed on the red image while superimposed on the green image and then on the blue image while superimposed on the green image.

The screen area is divided into 25 equal areas. Within each area it is possible to move the horizontal and vertical lines of the red and blue picture until they coincide with the green lines.

Use the arrow keys to make horizontal and vertical convergence adjustments in the area indicated by the box. Pressing **ENTER** will move the box to the next area of the setup pattern to be converged. Pressing **EXIT** will move the box back to the last area. The 'guided adjustment' program will start with the convergence adjustment of the red picture on the green and continues with the blue image on the green image.

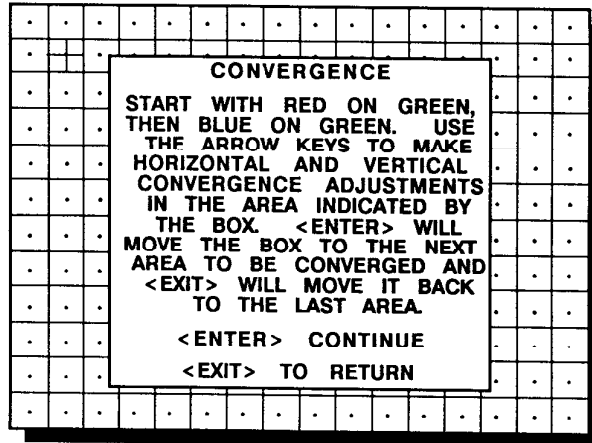

menu G6

<ENTER> continues to convergence adjustment
 <EXIT> returns to Size-Linearity adjustments (Menu G5).
 <ADJUST> returns to operational mode

25	23	9	15	17
24	22	8	14	16
5	4	1	2	3
20	18	6	10	12
21	19	7	11	13

GUIDED ADJUSTMENT MODE

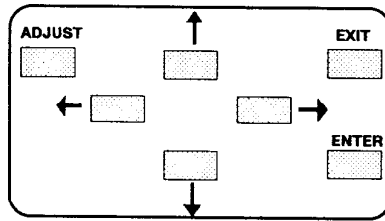
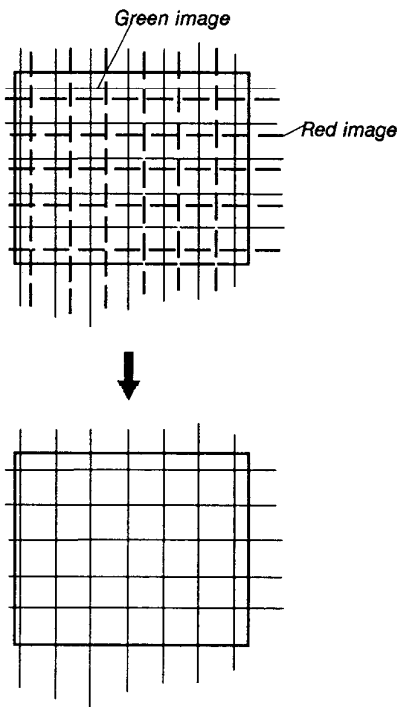
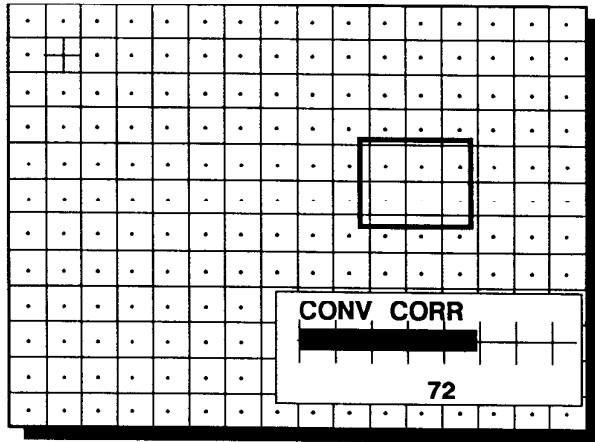

<ENTER> selects a new box and at the end it continues with the Blanking Adjustment, Menu G7.
 <EXIT> returns to the last area.

GUIDED ADJUSTMENT MODE

Blanking Adjustment

Blanking adjustments affect only the edges of the projected image and are used to frame the projected image on to the screen.

The following blanking corrections are possible :

- top blanking
- bottom blanking
- left blanking
- right blanking

Therefore :

- if the internal # pattern was selected, this pattern remains on the screen.
- if the genlocked pattern was selected, the external source will be displayed.

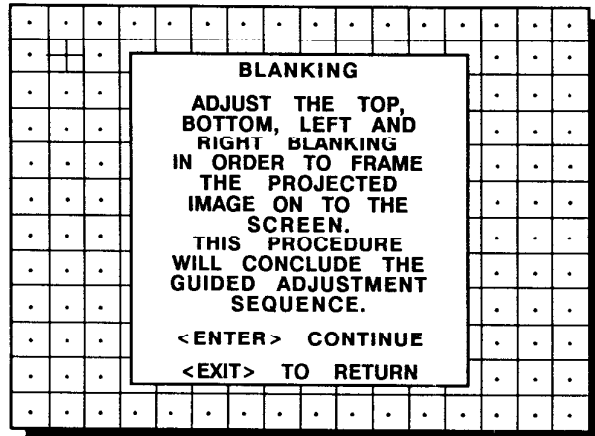

menu G7

<ENTER> continues to top blanking adjustment.
<EXIT> returns to convergence (Menu G6)
<ADJUST> returns to operational mode

GUIDED ADJUSTMENT MODE

Top blanking adjustment

Use the up or down key to adjust the top blanking of the setup pattern. Press **ENTER** to continue.

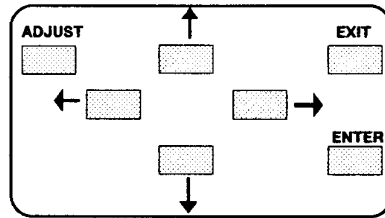
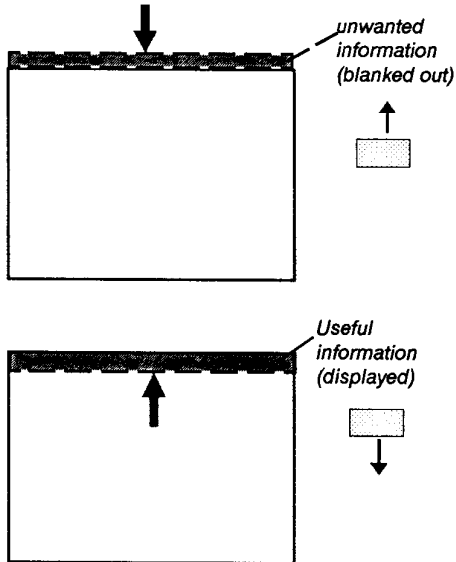
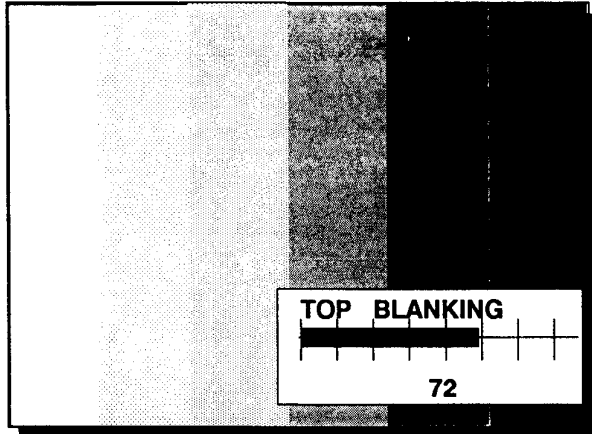

<ENTER> continues to bottom blanking adjustment.

<EXIT> returns to blanking adjustments (Menu G7).

GUIDED ADJUSTMENT MODE

Bottom blanking adjustment

Use the up or down key to adjust the bottom blanking of the setup pattern.

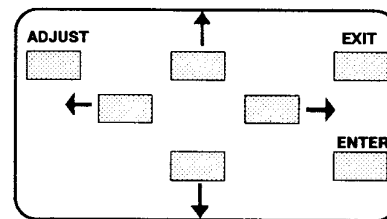
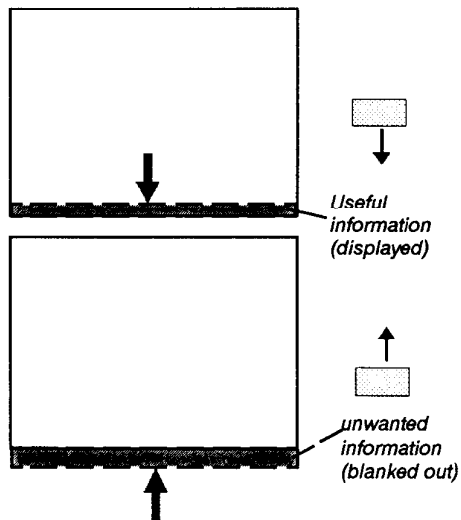
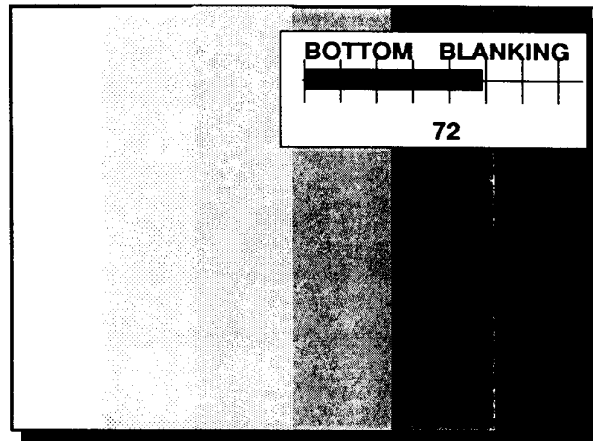

<ENTER> continues to left blanking adjustment.
<EXIT> returns to top blanking adjustments.

GUIDED ADJUSTMENT MODE

Left blanking adjustment

Use the left or right arrow key to adjust the left blanking of the setup pattern.

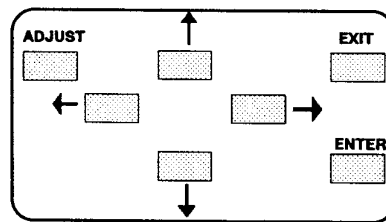
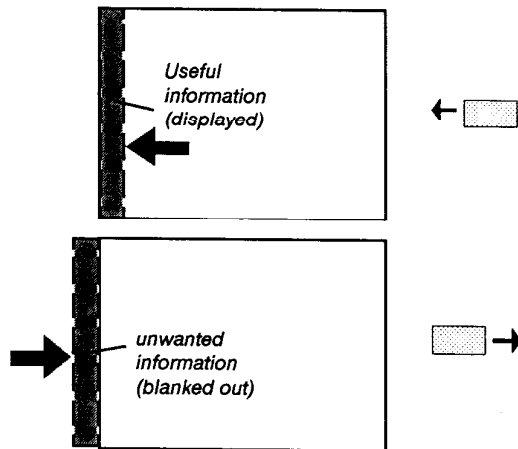
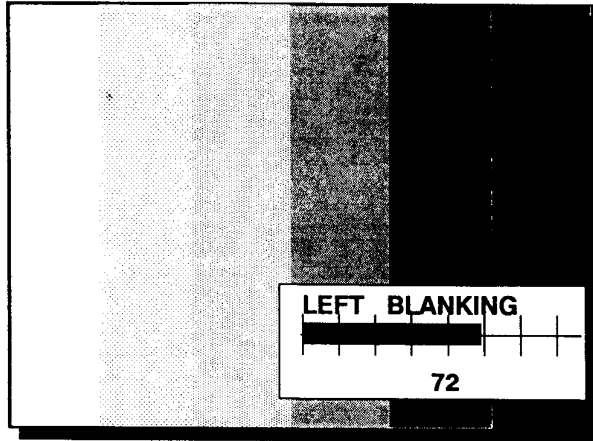

<ENTER> continues to right blanking adjustment.
<EXIT> returns to bottom blanking adjustments.

GUIDED ADJUSTMENT MODE

Right blanking adjustment

Use the left or right arrow key to adjust the right blanking of the setup pattern.

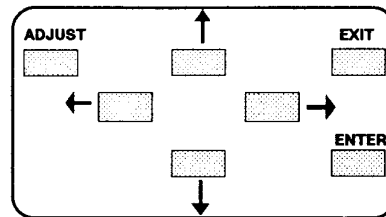
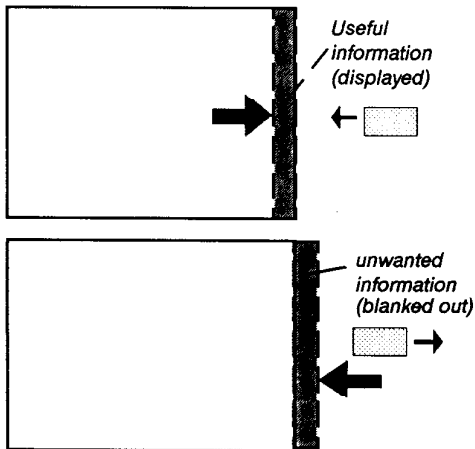
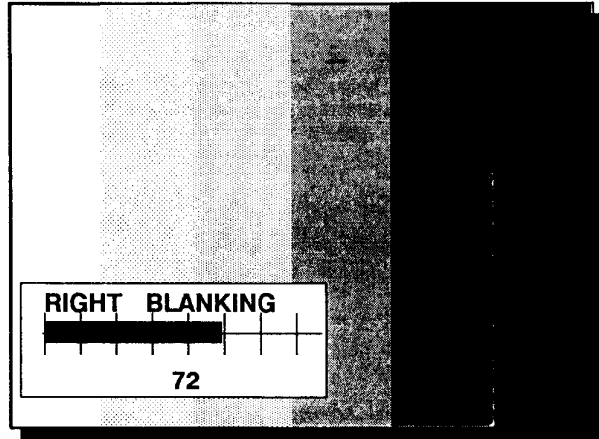

<ENTER> concludes the Guided Adjustment Sequence.
<EXIT> returns to left blanking adjustments.

RANDOM ACCESS ADJUSTMENT MODE

RANDOM ACCESS ADJUSTMENT MODE

STARTING UP THE RANDOM ACCESS ADJUSTMENT MODE

OVERVIEW FLOW CHARTS

SYNC FAST/SLOW

ENHANCED BLUE ON/OFF

COLOR SELECT

COLOR ADJUSTMENTS

WHITE BALANCE

BLACK BALANCE

GEOMETRY-CONVERGENCE ADJUSTMENT

GREEN GEOMETRY ADJUSTMENT

HORIZONTAL PHASE

RASTER SHIFT

LEFT-RIGHT ADJUSTMENTS

VERTICAL CENTERLINE BOW

VERTICAL CENTERLINE SKEW

SIDE KEYSTONE

SIDE BOW

TOP-BOTTOM ADJUSTMENTS

HORIZONTAL CENTERLINE BOW

TOP KEYSTONE

TOP BOW

BOTTOM KEYSTONE

BOTTOM BOW

HORIZONTAL SIZE

VERTICAL LINEARITY

VERTICAL SIZE

BLANKING

RED OR BLUE ON GREEN GEOMETRY ADJUSTMENTS

CONVERGENCE CORRECTIONS

RANDOM ACCESS ADJUSTMENT MODE

Starting up the random access adjustment mode.

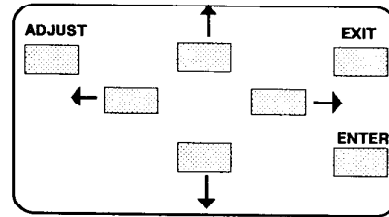

Use the arrow keys on the RCU800 to highlight "RANDOM ACCESS" and then press ENTER.

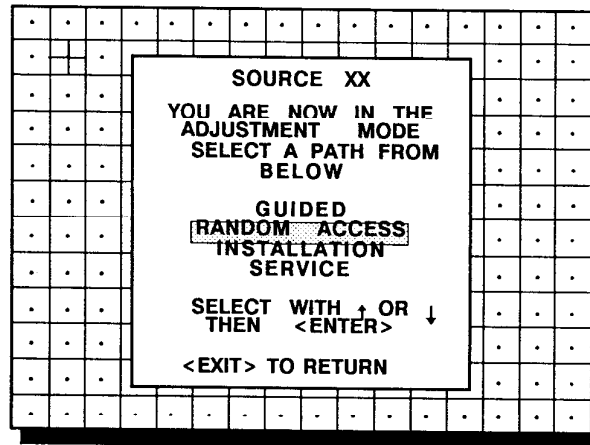

menu S1

<ENTER> continues to Setup Pattern Selection (Menu S2 or S3)
 <EXIT> returns to operational mode

RANDOM ACCESS ADJUSTMENT MODE

Overview flow chart 'Random Access Adjustment' mode.

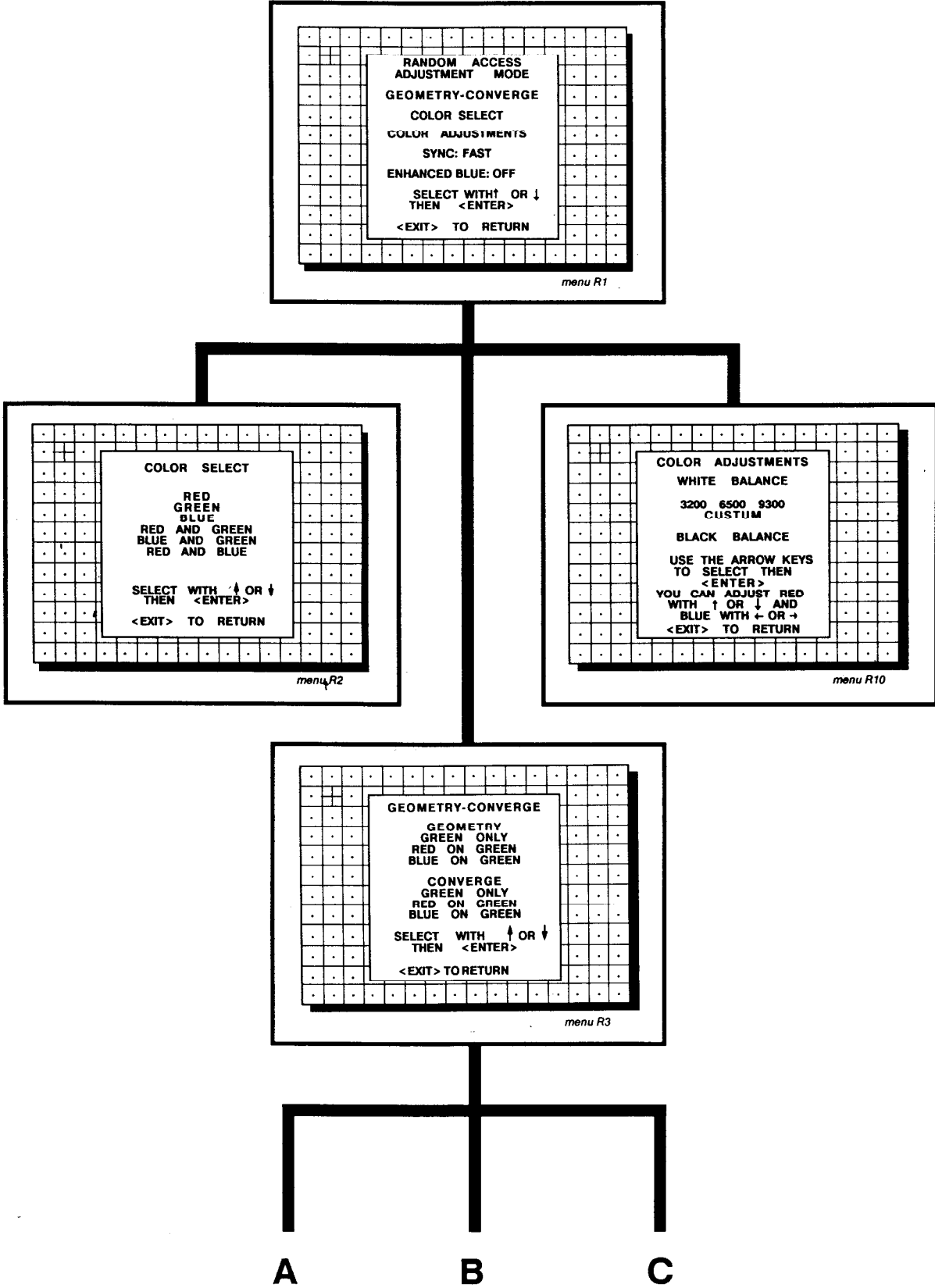

RANDOM ACCESS ADJUSTMENT MODE

A

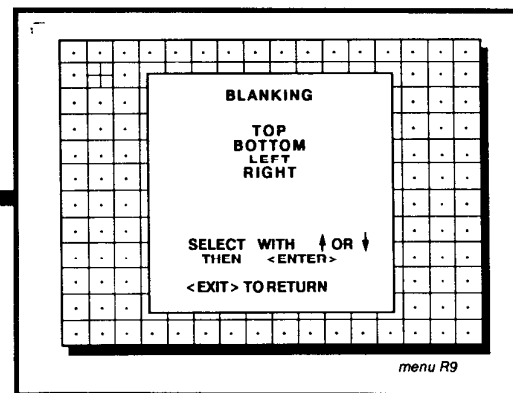
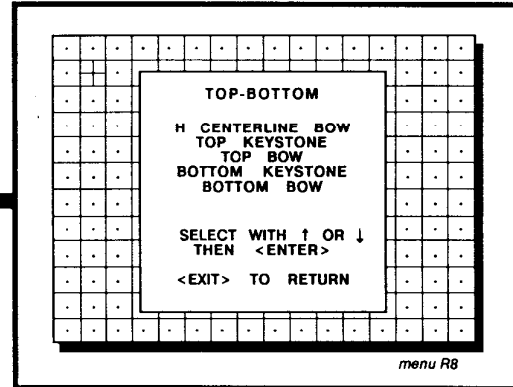
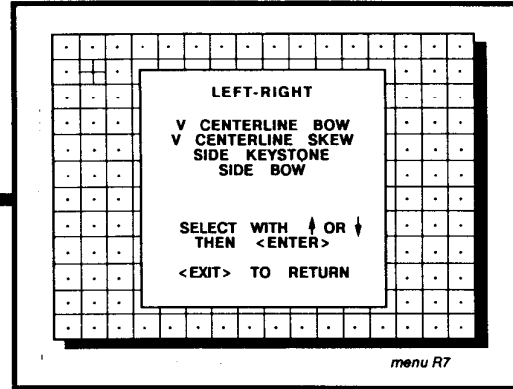
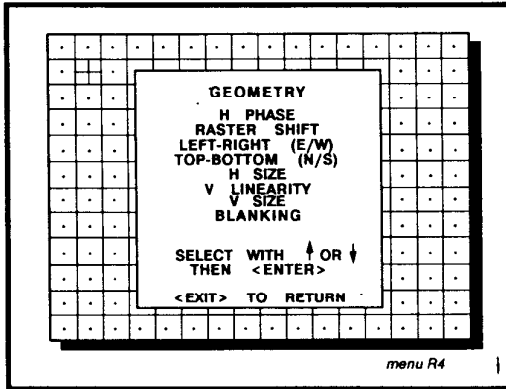

RANDOM ACCESS ADJUSTMENT MODE

B

GEOMETRY

RASTER SHIFT
TOP-BOTTOM (N/S)

SELECT WITH ↑ OR ↓
THEN <ENTER>

<EXIT> TO RETURN

menu R5

TOP-BOTTOM

H CENTERLINE BOW
TOP KEYSTONE
TOP BOW
BOTTOM KEYSTONE
BOTTOM BOW

SELECT WITH ↑ OR ↓
THEN <ENTER>

<EXIT> TO RETURN

menu R8

C

CONVERGE

SEL: SELECT AREA
USING ARROW
KEYS

ADJ: ADJUST AREA
USING ARROW
KEYS

TOGGLE BETWEEN
SEL AND ADJ WITH
<ENTER>

<ENTER> CONTINUE

<EXIT> TO RETURN

menu R6

RANDOM ACCESS ADJUSTMENT MODE

Selecting Setup Pattern

If an external source is connected to the projector, Menu S2 will be displayed. Use the arrow keys to highlight the desired setup pattern and then press **ENTER**.

Genlocked pattern : internally generated cross hatch pattern, locked on the external source.

Internal # pattern : internally generated cross hatch pattern and locked on internal generated sync signals. (No external source necessary)

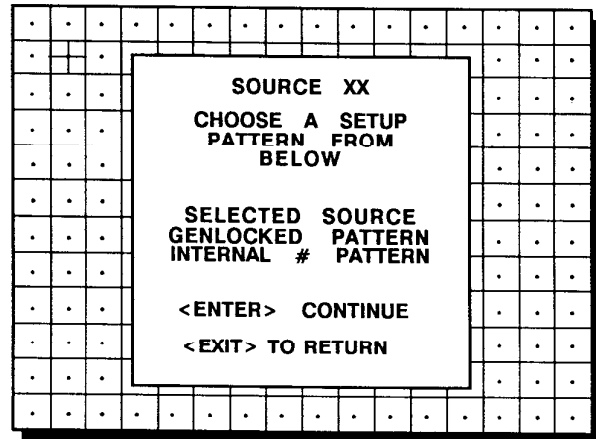

menu S2

<ENTER> continues to Random Access Adjustment Mode (Menu R1) or Internal # Pattern Selection (Menu S4)
<EXIT> returns to Path Selection (Menu S1)
<ADJUST> returns to operational mode

If no external source is connected to the projector, Menu S3 will be displayed. Press **ENTER** to select the internally generated cross hatch pattern.

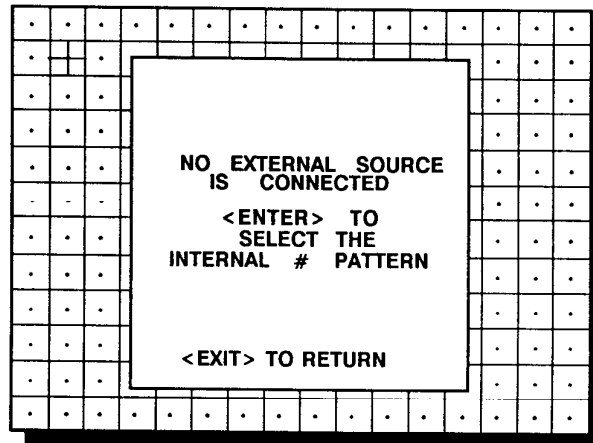

menu S3

<ENTER> continues to Internal # Pattern Selection (Menu S4)
<EXIT> returns to Path Selection (Menu S1)

RANDOM ACCESS ADJUSTMENT MODE

Internal Cross Hatch Pattern

Menu S4 will be displayed if the internal cross hatch pattern has been selected. The table below lists the 8 factory preset frequencies available.

Use the arrow keys to highlight the desired cross hatch frequency and then press **ENTER**.

STD: Fh = 15.6 KHz Fv = 50 Hz
 CGA: Fh = 15.7 KHz Fv = 60 Hz
 EGA: Fh = 21.9 KHz Fv = 60 Hz
 VGA: Fh = 31.5 KHz Fv = 60 Hz
 PR1: Fh = 35.0 KHz Fv = 60 Hz
 PR2: Fh = 48.0 KHz Fv = 60 Hz
 PR3: Fh = 64.0 KHz Fv = 60 Hz
 PR4: Fh = 90.0 KHz Fv = 60 HZ

It is possible to store user defined cross hatch frequencies in PR1 - PR4. Follow the steps below to program a custom cross hatch frequency.

1. Highlight the desired storage location (PR1 - PR4) on menu S4.
2. Press **TEXT** to reprogram.
3. Use the arrow keys to select the digits to be changed.
4. Reprogram the desired horizontal frequency as XX.X KHz and the vertical frequency as XXX Hz using the numeric keys.
5. Press **ENTER** to confirm.

Example: Desired cross hatch frequency:

Fh = 34.8 KHz
 Fv = 60 Hz

Use arrow keys to highlight the desired storage location (PR1 - PR4) and press **TEXT**. The reprogram menu appears on the screen. Use the arrow keys to go to the first digits of the horizontal frequency and

Press 3 4 8 0 6 0 **<ENTER>**

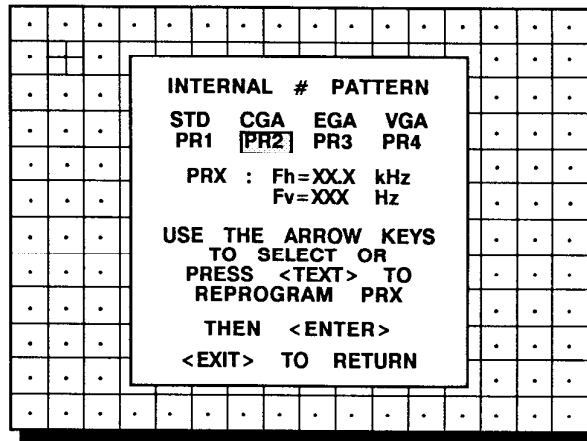

menu S4

<ENTER> continues to Random Access adjustment mode (Menu R1)
 <EXIT> returns to Setup Pattern Selection (Menu S2 or S3)
 <TEXT> gives the reprogram menu (Menu S4 bis)

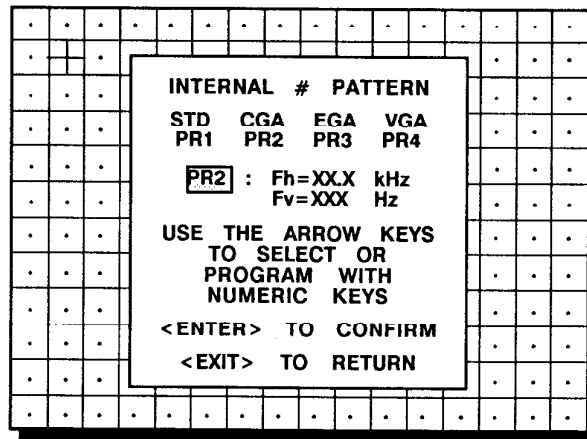

menu S4

<ENTER> confirms your entry and continues to Random Access Adjustment Mode (Menu R1)
 <EXIT> returns to Setup Pattern Selection (Menu S2 or S3)

RANDOM ACCESS ADJUSTMENT MODE

Random access adjustment mode selection menu.

Menu R1 is the main menu for the Random Access adjustment mode. Through this menu, the following adjustments and features are accessible :

- Geometry-convergence
- Color select
- Sync : slow/fast
- Enhanced blue : on/off

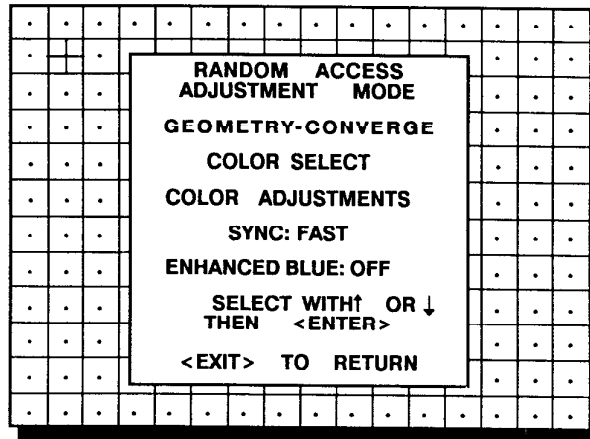

menu R1

Sync Fast/Slow Adjustment

Highlight SYNC with the arrow keys and press ENTER to toggle between FAST and SLOW.

Note: SYNC is normally used in the SLOW position. The FAST position is used to compensate for unsteady sync pulses from older video playback equipment.

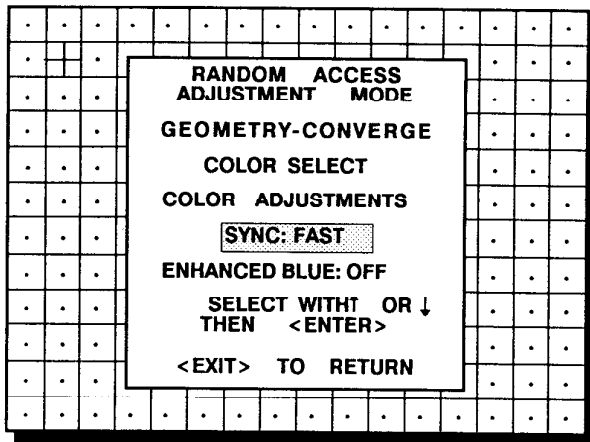

menu R1

<ENTER> will toggle Sync between FAST and SLOW
 <EXIT> will return to Internal Crosshatch Selection (Menu S4) or Setup Pattern Selection (Menu S2)

RANDOM ACCESS ADJUSTMENT MODE

Enhanced Blue On/Off Adjustment

Highlight *ENHANCED BLUE* with the arrow keys and press **ENTER** to toggle between *ON* and *OFF*. (only available when RGB signals are connected)

When 'Enhanced Blue' is *ON*, the blue color will be displayed as cyanic.

Note: Enhanced blue is only use when an RGBS or RGsB analog signal from a computer is being displayed. Enhanced blue is not recommended for non computer generated images.

For displaying graphics, this 'Enhanced Blue' function could falsify the color reproduction. In this case, put Enhanced Blue' *OFF*.

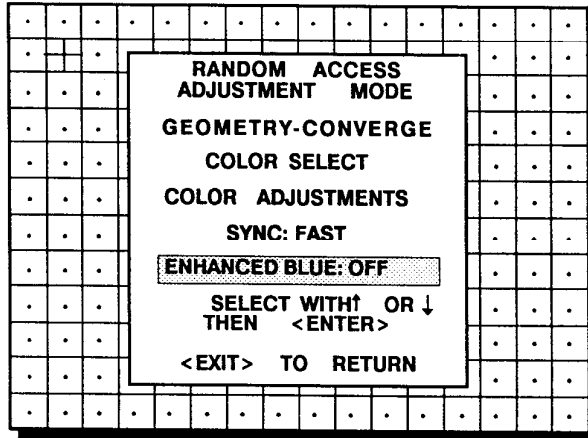

menu R1

<ENTER> will toggle Enhanced Blue between *ON* and *OFF*

<EXIT> will return to Internal Crosshatch Selection (Menu S4) or Setup Pattern Selection (Menu S2)

<ADJUST < returns to operational mode

Color Select

Highlight *COLOR SELECT* with the arrow keys and press **ENTER** to display menu R2.

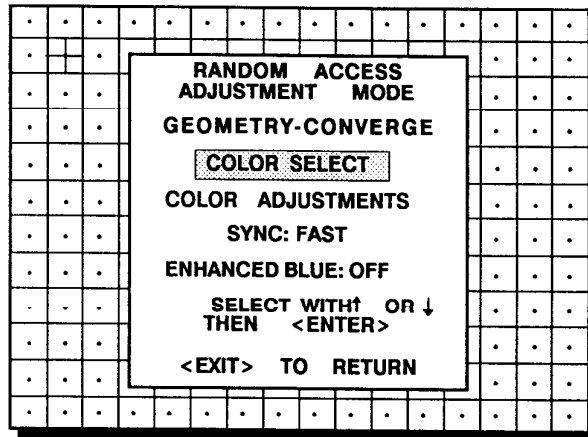

menu R1

<ENTER> continues to the color select menu, menu R2

<EXIT> will return to Internal Crosshatch Selection (Menu S4) or Setup Pattern Selection (Menu S2)

<ADJUST > returns to operational mode

RANDOM ACCESS ADJUSTMENT MODE

Use the arrow keys to highlight a color (CRT) or combination thereof to display the projected image from.

To select a new color, press **ENTER**, menu R2 appears again on the screen. To terminate the color select procedure, press **EXIT**.

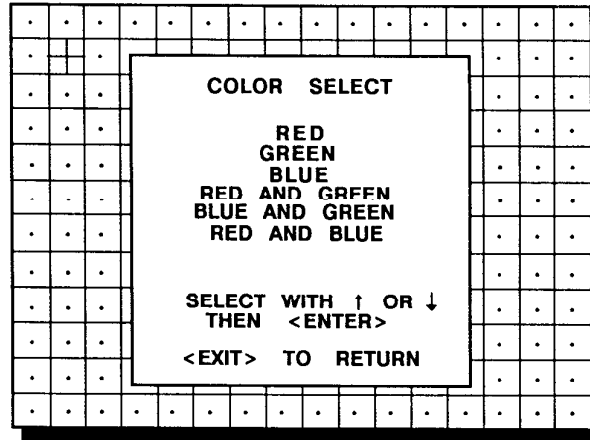

menu R2

<ENTER> continues with color select menu (Menu R2)

<EXIT> will return to menu R1.

Color adjustments

Highlights *Color adjustments* with the arrow keys and press **ENTER** to display menu R10.

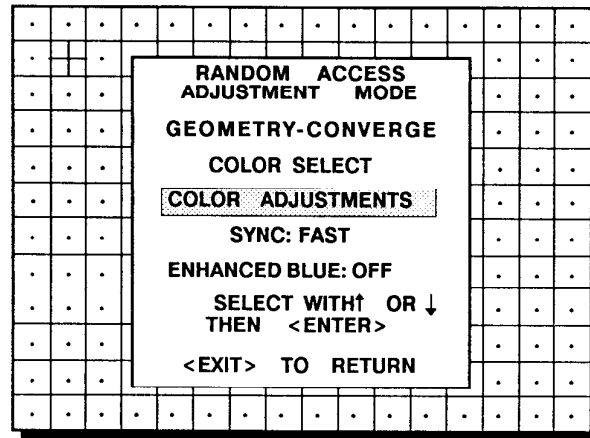

menu R1

<ENTER> continues with the color temperature and the color cut off.

<EXIT> returns to Internal Crosshatch Selection (Menu S4) or Setup Pattern Selection (Menu S2)

<ADJUST> returns to operational mode.

RANDOM ACCESS ADJUSTMENT MODE

White balance

Use the arrow keys to select a *white balance* and press **ENTER**.

The table below lists the possible choices :

- 3200°K
- 6500°K
- 9300°K
- CUSTOM

When custom is selected, the gain for Red and Blue can be adjusted with the arrow keys until the desired white balance is obtained.

Use the left and right arrow keys to adjust the Red gain. Use the up and down arrow keys to adjust the Blue gain.

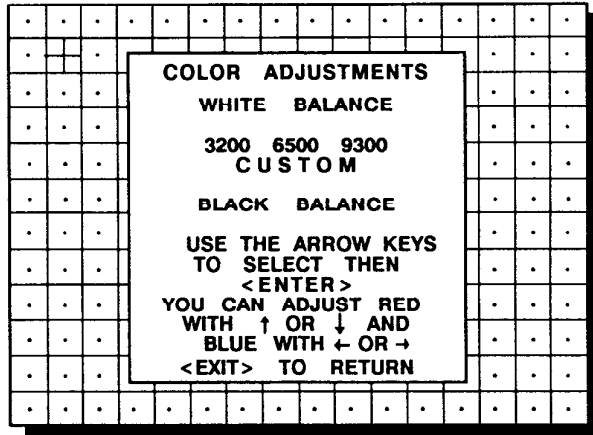

menu R10

<ENTER> returns to menu R1, and stores the selected white balance.

<EXIT> returns to menu R1

<ADJUST> returns to operational mode.

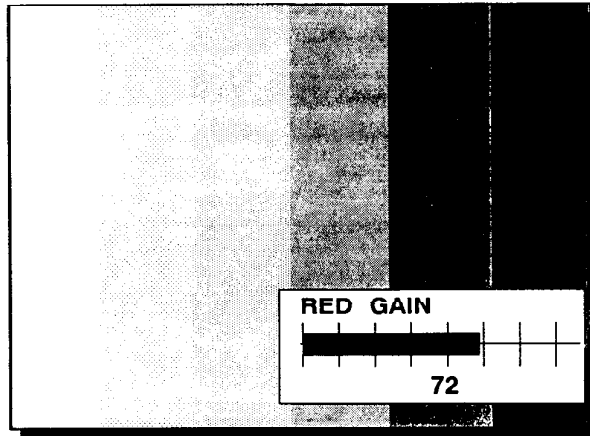

RANDOM ACCESS ADJUSTMENT MODE

Black balance

Use the arrow keys to select *black balance* and then press ENTER.

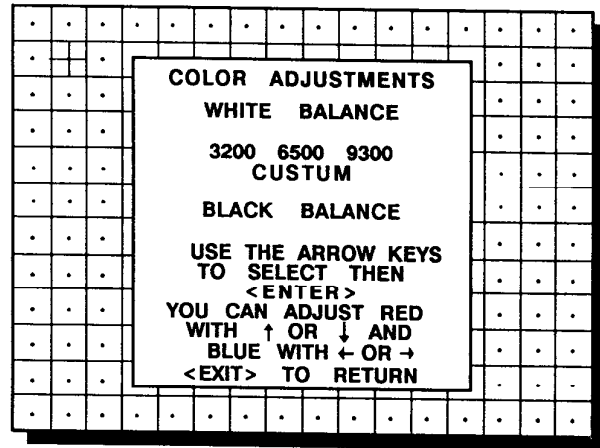

menu R10

<ENTER> selects the black balance adjustment.
<EXIT> returns to Random Access Adjustment Mode main menu (Menu R1).
<ADJUST> returns to operational mode.

Use the left and right arrow keys to adjust the 'blue cut off' and use the top and bottom arrow keys to adjust the 'red cut off'. Both adjustments give the correct '*black balance*' (*grey scale*).

A bar scale and a number indicator on the screen give a visual indication of the 'cut off' adjustment.

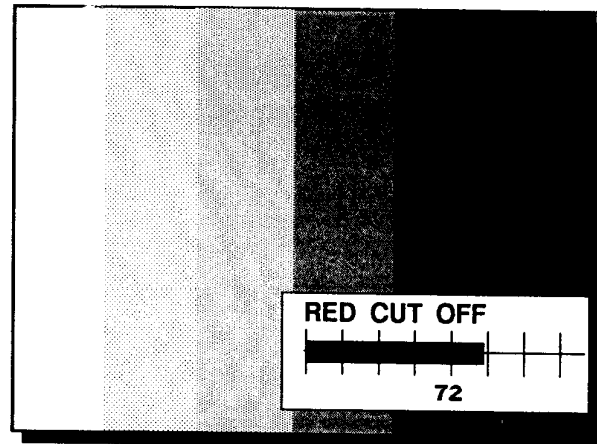

<ENTER> returns to the Color Adjustments menu, menu R10.

RANDOM ACCESS ADJUSTMENT MODE

Geometry - Convergence Adjustments

Start first with geometry and continue with the convergence adjustments. The geometry adjustment has to be started with the green picture. Some of these adjustments are automatically implemented for the other color pictures, such as : Left-right (EW) corrections, blanking, Horizontal amplitude, vertical amplitude, vertical linearity and Horizontal phase. When the geometry for green is adjusted, continue with the geometry of red on green or the geometry of blue on green.

Continue with the convergence adjustment, but keep in mind to start with green convergence only when this feature is available, then with red on green and then with blue on green.

Highlight *GEOMETRY-CONVERGE* with the arrow keys and press **ENTER** to display menu R3.

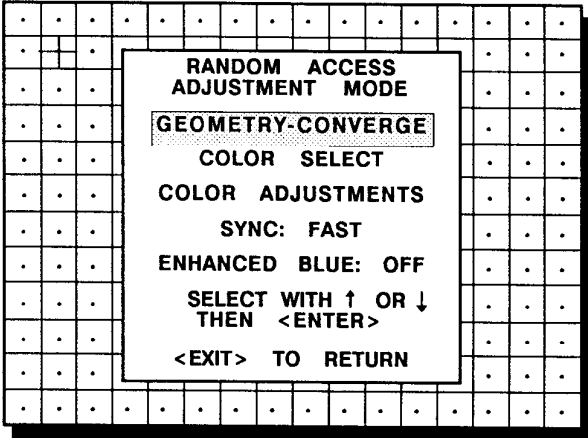

menu R1

<ENTER> will display Geometry-Converge menu (Menu R3)
 <EXIT> will return to Internal Crosshatch Selection (Menu S4) or Setup Pattern Selection (Menu S2)
 <ADJUST> returns to operational mode

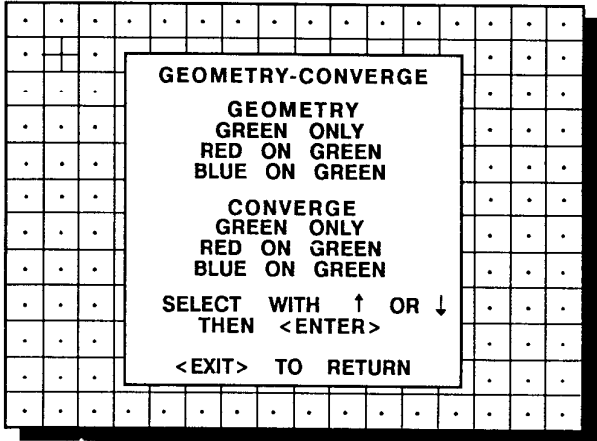

menu R3

RANDOM ACCESS ADJUSTMENT MODE

Green Geometry Adjustments

Highlight *GREEN ONLY* under GEOMETRY with the arrow keys and press **ENTER** to display menu R4.

WITH *GREEN ONLY* you can adjust :

- horizontal phase
- left-right corrections
- top-bottom corrections
- horizontal size
- vertical linearity
- vertical size
- blanking

The convergence corrections and the blanking adjustments are disabled during geometry corrections.

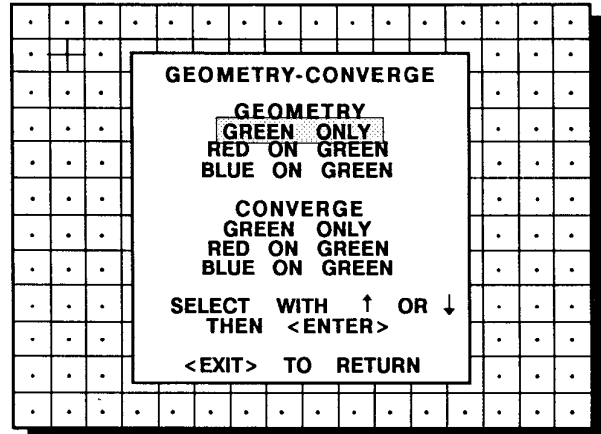

menu R3

<ENTER> will display Geometry menu (Menu R4)
<EXIT> will return to Random Access Adjustment Mode main menu (Menu R1)
<ADJUST> returns to operational mode

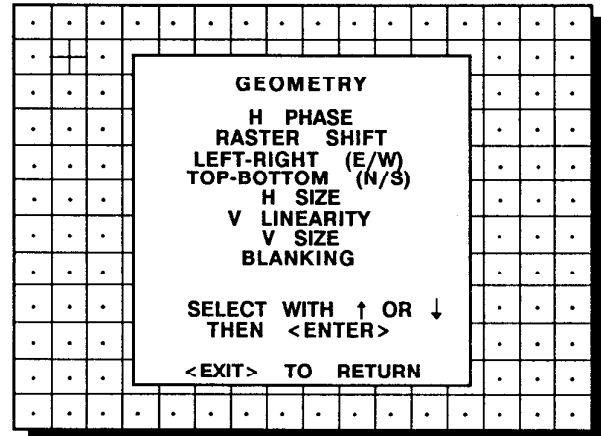

menu R4

RANDOM ACCESS ADJUSTMENT MODE

Horizontal Phase Adjustment

Use the arrow keys to highlight **H PHASE** on menu R4 and then press **ENTER**.

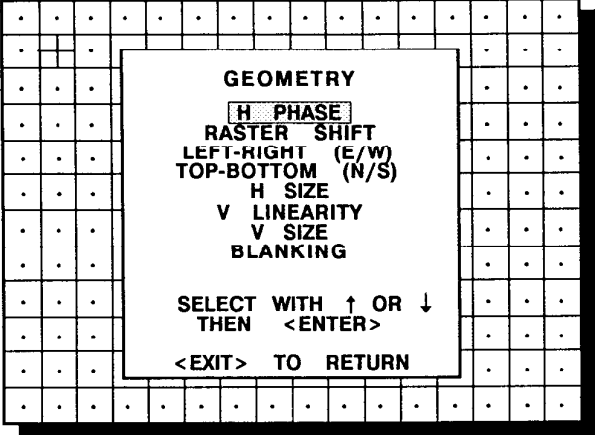

menu R4

Adjust the horizontal phase with the arrow keys until full characters are displayed on the left and right side of the picture. Therefore :

- if the internal # pattern was selected, this pattern remains on the screen
- if the genlocked pattern was selected, the external source will be displayed

A bar scale and a number indicator on the screen give a visual indication of the horizontal phase adjustment.

<ENTER> will select horizontal phase adjustment
 <EXIT> will return to Geometry-converge menu (Menu R3)
 <ADJUST> returns operational mode

In order to optimize the image quality, the image should be shifted to the 'end of scan' side of the raster. For front screen applications, the 'end of scan' side of the raster is on the right hand side of the screen. For rear screen applications, it is on the left hand side.
 Decrease the contrast and increase the brightness level until the raster becomes visible on the screen. Use the left or right

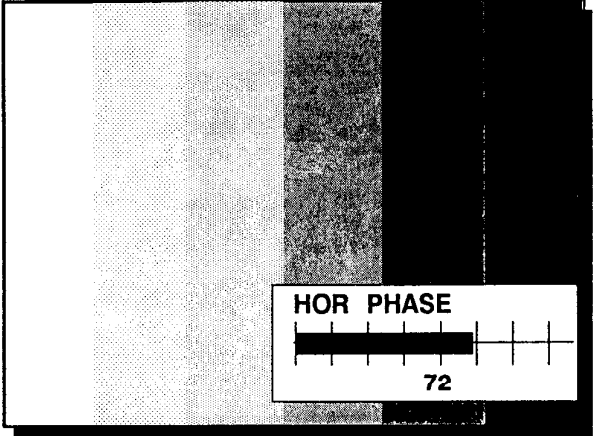

Correct with right arrow key



Correct with left arrow key

arrow keys to shift the setup pattern to the proper position on the raster. Restore the brightness and contrast to normal levels after performing the horizontal phase adjustment.

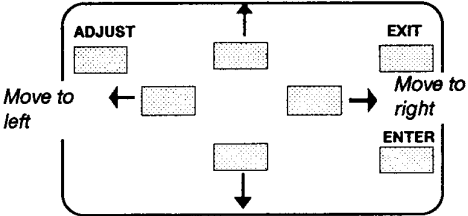

<ENTER> continues to geometry menu (Menu R4)

RANDOM ACCESS ADJUSTMENT MODE

Raster Shift Adjustment

The green raster must be centered both horizontally and vertically on the center of the CRT surface. To center the green raster, look into the green lens and use the arrow keys to move the raster.

CAUTION

It is necessary to look into the lenses to perform the following adjustments. To avoid eye discomfort while looking into the lenses, reduce the contrast and gradually increase the brightness level until the raster becomes visible on the face of the CRT.

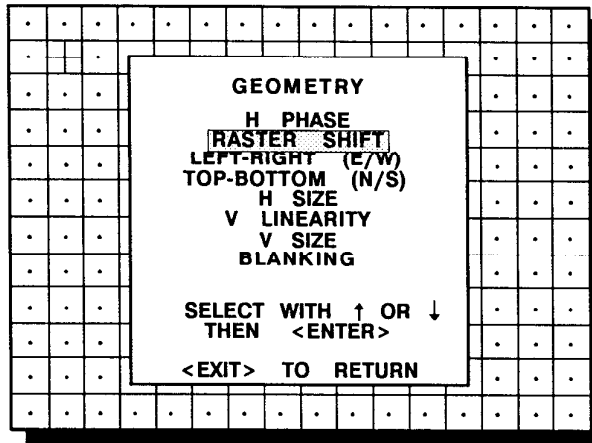

menu R4

<ENTER> will select green raster shift adjustment
 <EXIT> will return to Geometry-Converge menu (Menu R3)
 <ADJUST> returns to operational mode

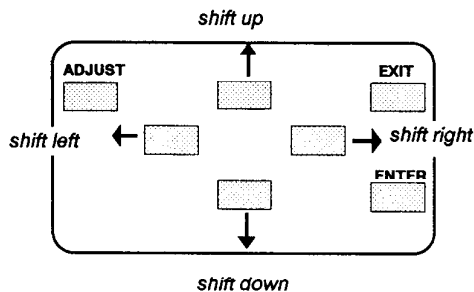
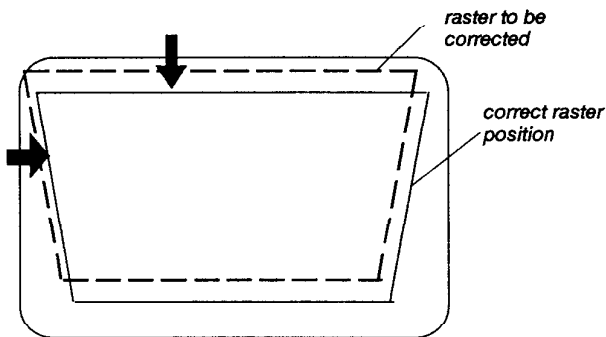

<EXIT> will return to Geometry (Menu R4)

RANDOM ACCESS ADJUSTMENT MODE

Left-Right (east-west) Adjustments

Left-right adjustments affect only the vertical lines of the projected image. Only the green image is displayed while making left-right adjustments. The red and blue images will automatically be corrected in the same manner. Convergence corrections are automatically disabled for the duration of these adjustments.

The following adjustments can be executed

- vertical centerline bow
- vertical centerline skew
- side keystone
- side bow

Use the arrow keys to highlight *LEFT-RIGHT (E/W)* on menu R4 and then press **ENTER**.

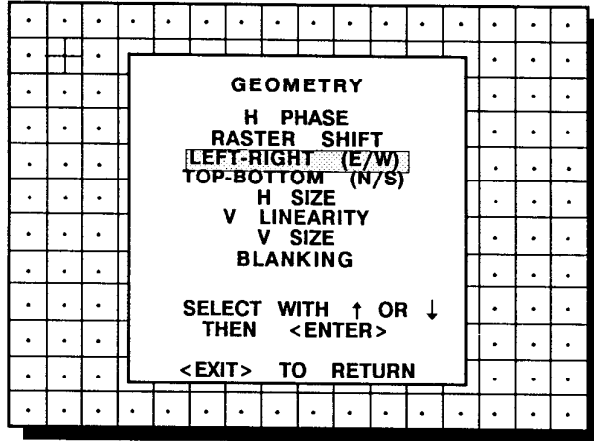

menu R4

- <ENTER> will select Left-Right adjustment menu (Menu R7)
- <EXIT> will return to Geometry-Converge menu (Menu R3)
- <ADJUST> returns to operational mode

RANDOM ACCESS ADJUSTMENT MODE

Vertical Centerline Bow Adjustment

Use the arrow keys to highlight **V CENTERLINE BOW** on Menu R7 and then press **ENTER**.

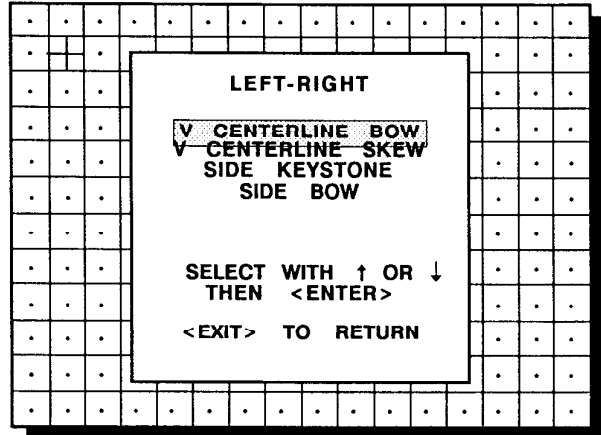

menu R7

<ENTER> will select vertical centerline bow adjustment
 <EXIT> will return to Geometry menu (Menu R4)
 <ADJUST> returns to operational mode

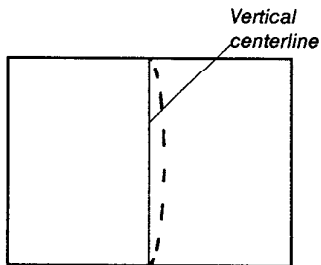
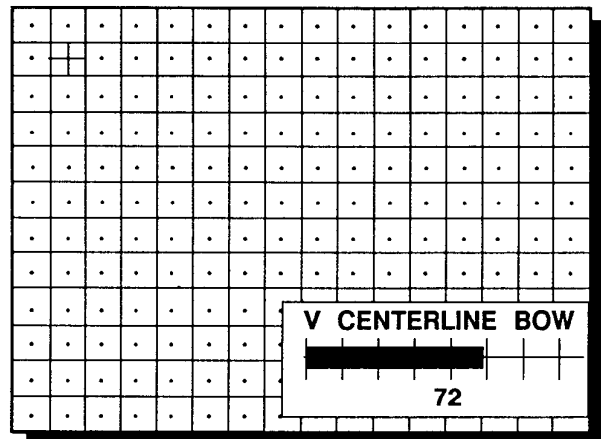

Correct with left arrow key

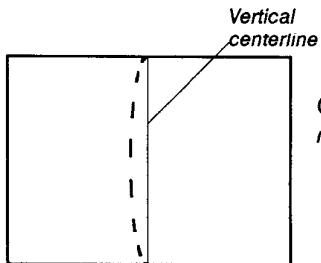

Correct with right arrow key

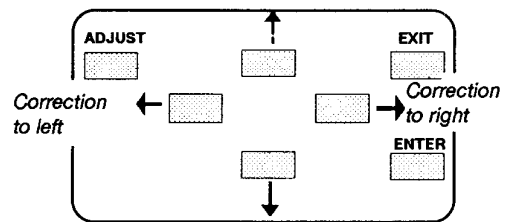

<ENTER> will return to Left-Right adjustment menu (Menu R7)
 <EXIT> will return to Geometry menu (Menu R4)

RANDOM ACCESS ADJUSTMENT MODE

Vertical Centerline Skew Adjustment

Use the arrow keys to highlight **V CENTERLINE SKEW** on Menu R7 and then press **ENTER**

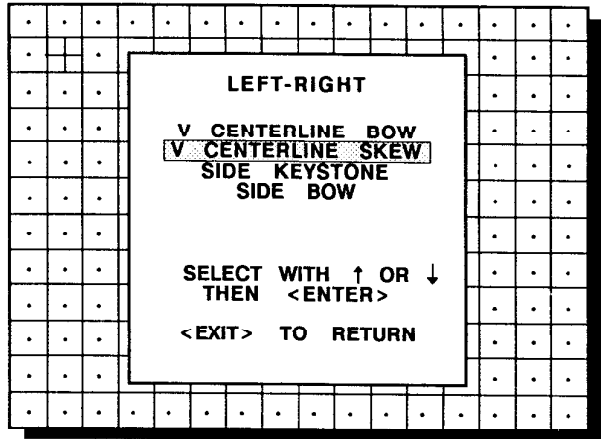

menu R7

<ENTER> will select vertical centerline skew adjustment
 <EXIT> will return to Geometry menu (Menu R4)
 <ADJUST> returns to operational mode

Adjust with the left and right arrow key until the vertical centerline is straight. Misalignment of the outer vertical lines will be corrected with the bow and keystone corrections. Press **ENTER** to continue.

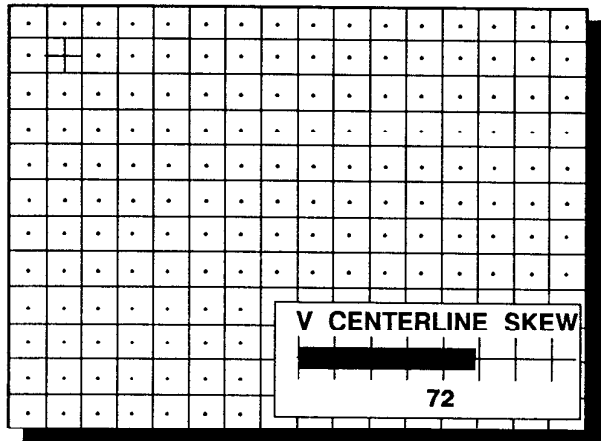

Vertical centerline

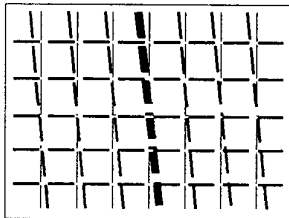

Correct with right arrow key



Vertical centerline

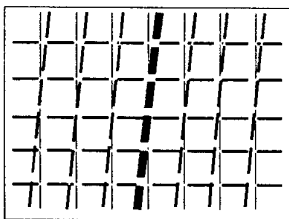

Correct with left arrow key

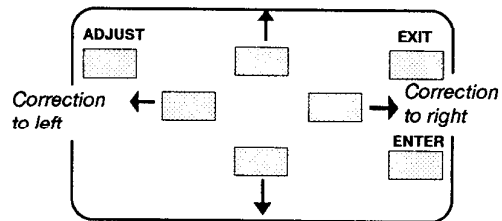

<ENTER> will return to Left-Right adjustment menu (Menu R7)
 <EXIT> will return to Geometry menu (Menu R4)

RANDOM ACCESS ADJUSTMENT MODE

Side Keystone Adjustment

Use the arrow keys to highlight *SIDE KEYSTONE* on Menu R7 and then press **ENTER**.

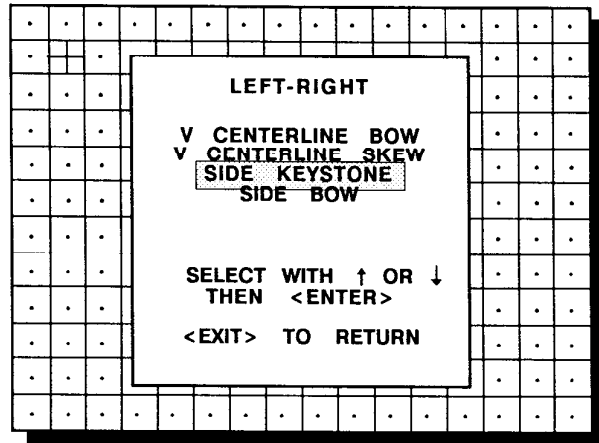

menu R7

<ENTER> will select side keystone adjustment
 <EXIT> will return to Geometry menu (Menu R4)
 <ADJUST> returns to operational mode

Use the left or right arrow key to adjust the side keystone (vertical lines) of the setup pattern and press **ENTER** to continue.

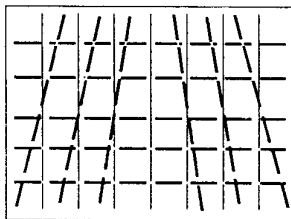
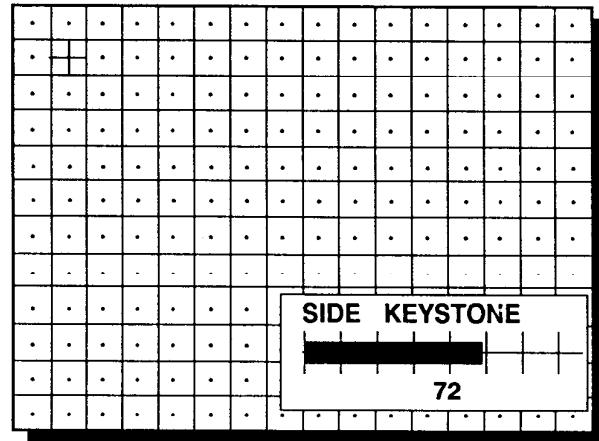

Correct with right arrow key

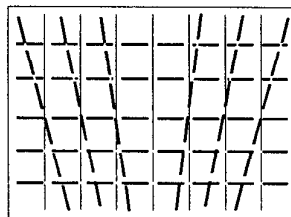

Correct with left arrow key

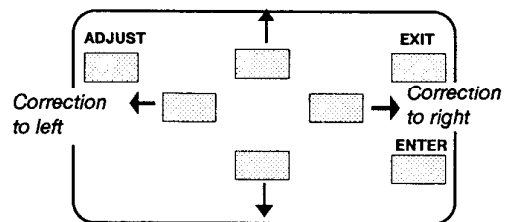

<ENTER> will return to Left-Right adjustment menu (Menu R7)
 <EXIT> will return to Geometry menu (Menu R4)

RANDOM ACCESS ADJUSTMENT MODE

Side Bow Adjustment

Use the arrow keys to highlight *SIDE BOW* on Menu R7 and then press **ENTER**.

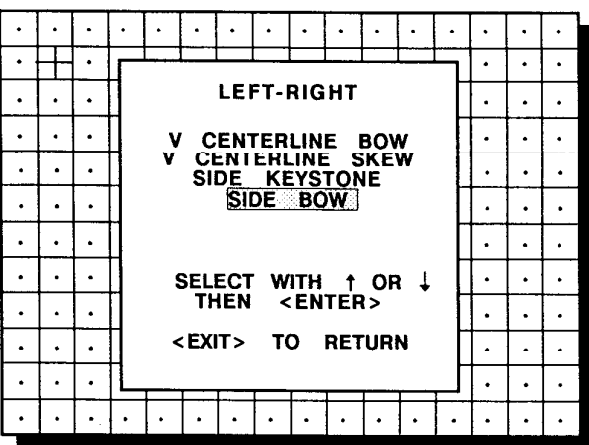

menu R7

<ENTER> will select side bow adjustment
 <EXIT> will return to Geometry menu (Menu R4)
 <ADJUST> returns to operational mode

Use the left or right arrow key to adjust the side bow of the setup pattern (vertical lines) and press **ENTER** to continue.

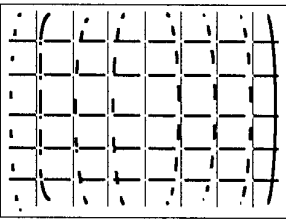
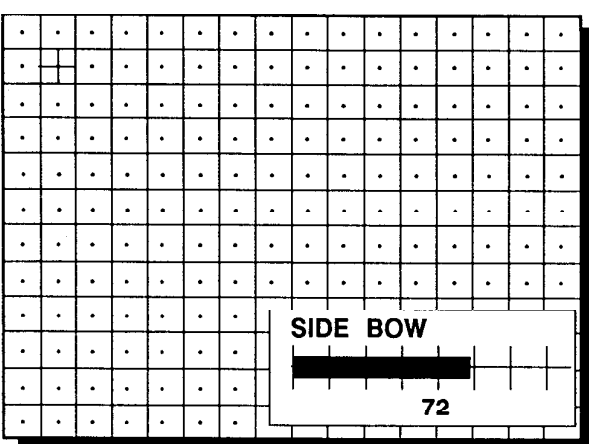

Correct with right arrow key

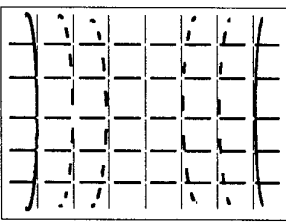

Correct with left arrow key

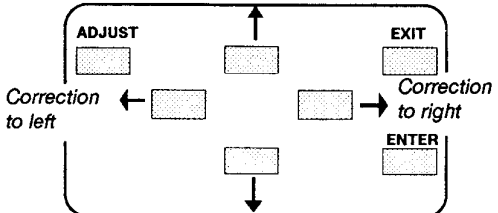

<ENTER> will return to Left-Right adjustment menu (Menu R7)
 <EXIT> will return to Geometry menu (Menu R4)

RANDOM ACCESS ADJUSTMENT MODE

Top-Bottom (north-south) Adjustments

Top-Bottom adjustments affect only the horizontal lines of the projected image. These adjustments are performed on the green image first. Repeat if necessary with the red and/or the blue image while superimposed on the green image. Convergence corrections are automatically disabled for the duration of these adjustments.

Use the arrow keys to highlight *TOP-BOTTOM (N/S)* on menu R4 and then press **ENTER**.

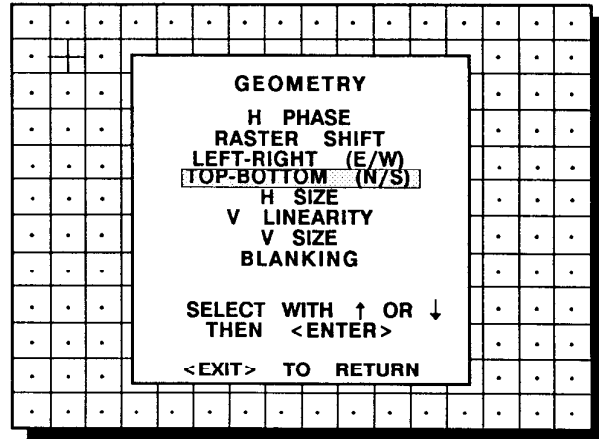

menu R4

<ENTER> will select Top-Bottom adjustment menu (Menu R8)
 <EXIT> will return to Geometry-Converge menu (Menu R3)
 <ADJUST> returns to operational mode

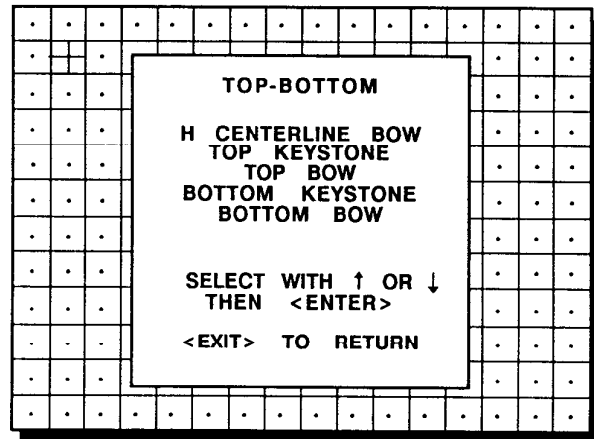

menu R8

<EXIT> will return to Geometry (Menu R4)

RANDOM ACCESS ADJUSTMENT MODE

Horizontal Centerline Bow Adjustment

Use the arrow keys to highlight *H CENTERLINE BOW* on menu R8 and then press **ENTER**.

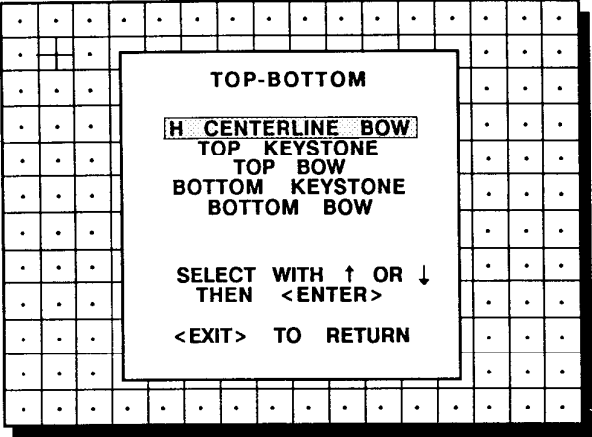

<ENTER> will select horizontal centerline bow adjustment
 <EXIT> will return to Geometry menu (Menu R4)
 <ADJUST> returns to operational mode

Use the up and down arrow key to adjust the horizontal centerline bow of the setup pattern. A bar scale and a number indicator will give a visual indication of the bow correction.

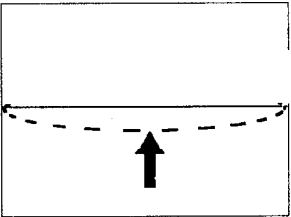
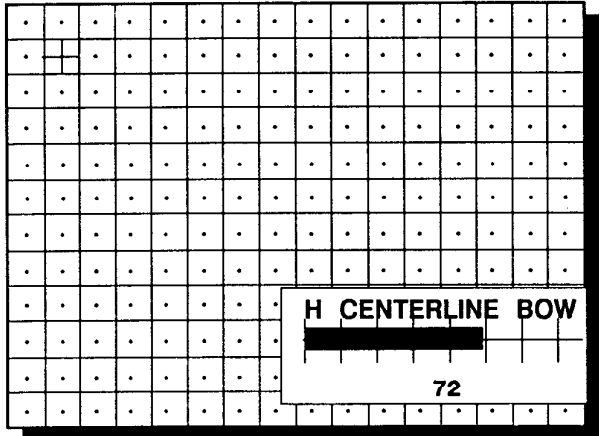

Correct with up arrow key

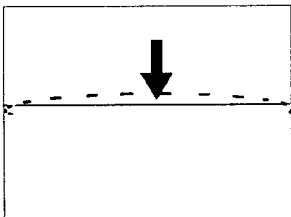

Correct with down arrow key

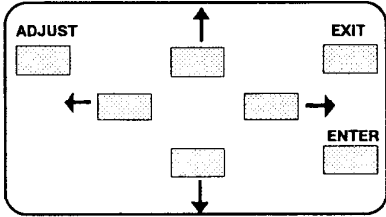

<ENTER> will return to Top-Bottom adjustment menu (Menu R8)
 <EXIT> will return to Geometry menu (Menu R4)

RANDOM ACCESS ADJUSTMENT MODE

Top Keystone Adjustment

Use the arrow keys to highlight **TOP KEYSTONE** on menu R8 and then press **ENTER**.

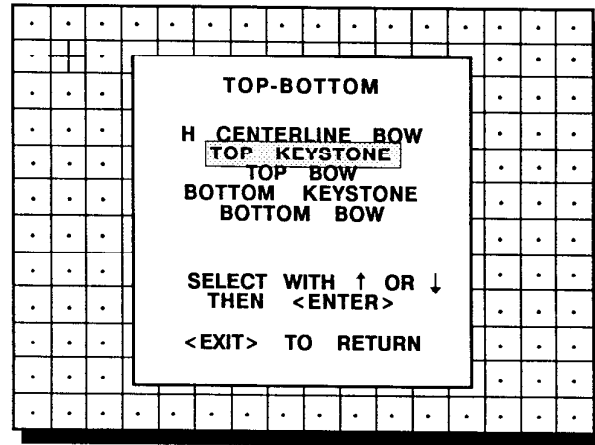

menu R8

<ENTER> will select top keystone adjustment
 <EXIT> will return to Geometry menu (Menu R4)
 <ADJUST> returns to operational mode

Adjust the horizontal lines in the upper part of the picture with the arrow keys until these lines straight. Press **ENTER** to continue.

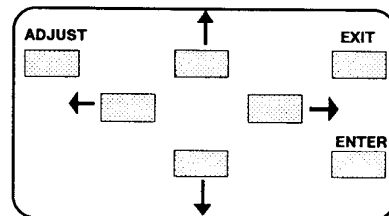
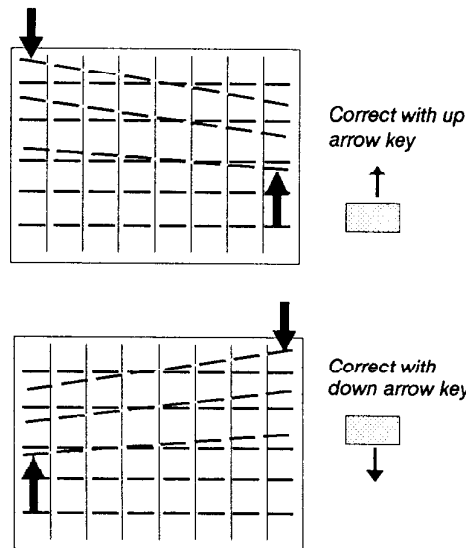
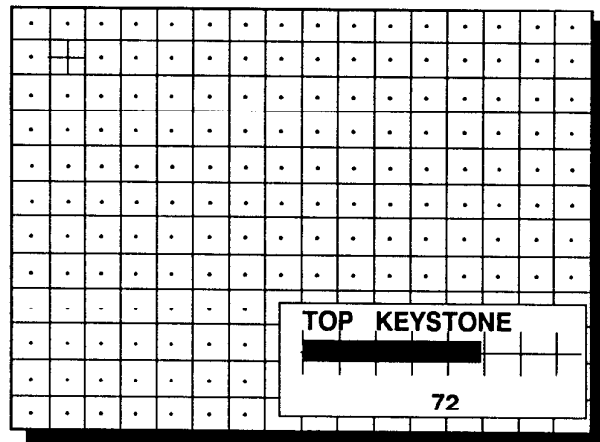

<ENTER> will return to Top-Bottom adjustment menu (Menu R8)
 <EXIT> will return to Geometry menu (Menu R4)

RANDOM ACCESS ADJUSTMENT MODE

Top Bow Adjustment

Use the arrow keys to highlight *TOP BOW* on menu R8 and then press **ENTER**.

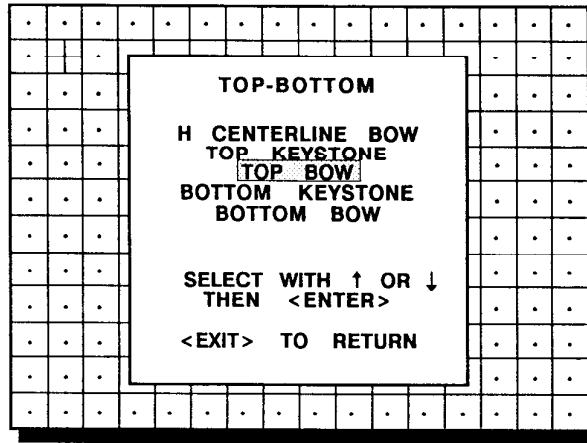

menu R8

<ENTER> will select top bow adjustment
 <EXIT> will return to Geometry menu (Menu R4)
 <ADJUST> returns to operational mode

Adjust the bow of the horizontal lines in the upper side of the image with the arrow keys until these lines are straight. A bar scale and a number indicator indicate the amount of adjustment.

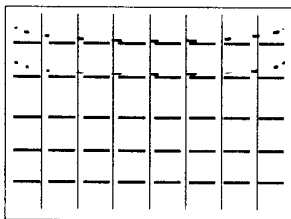
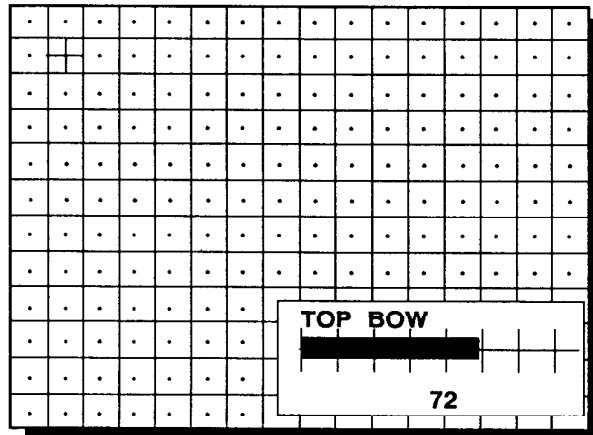

Correct with downarrow key

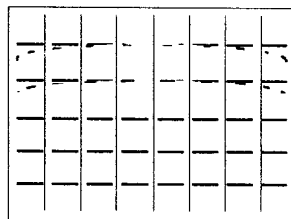

Correct with up arrow key

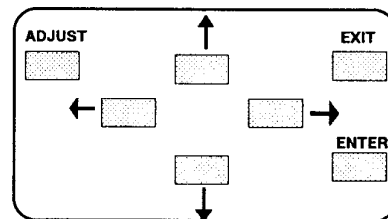

<ENTER> will return to Top-Bottom adjustment menu (Menu R8)
 <EXIT> will return to Geometry menu (Menu R4)

RANDOM ACCESS ADJUSTMENT MODE

Bottom Keystone Adjustment

Use the arrow keys to highlight **BOTTOM KEYSTONE** on menu R8 and then press **ENTER**.

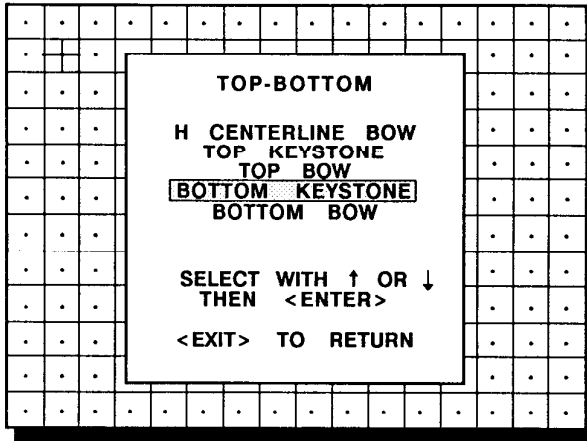

menu R8

<ENTER> will select bottom keystone adjustment
 <EXIT> will return to Geometry menu (Menu R4)
 <ADJUST> returns to operational mode

Adjust the horizontal lines in the lower part of the image with the arrow keys until these lines are straight. A bar scale and a number indicator will give a visual indication of the adjustment.

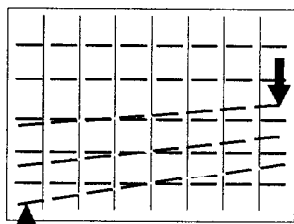
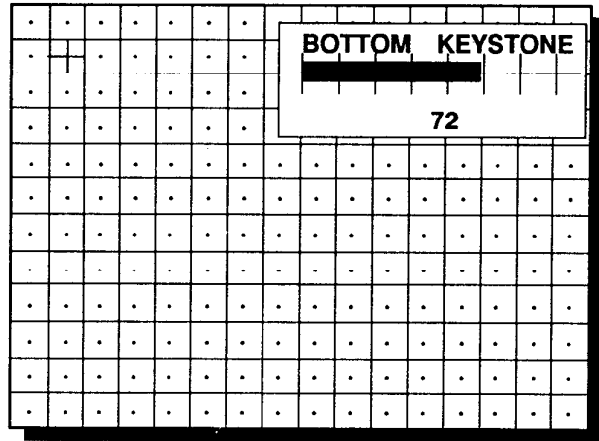

Correct with down arrow key

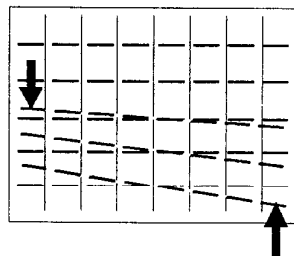

Correct with up arrow key

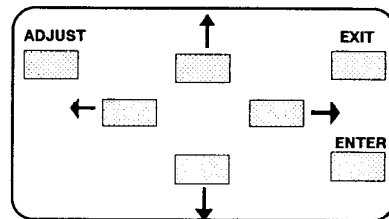

<ENTER> will return to Top-Bottom adjustment menu (Menu R8)
 <EXIT> will return to Geometry menu (Menu R4)

RANDOM ACCESS ADJUSTMENT MODE

Bottom Bow Adjustment

Use the arrow keys to highlight *BOTTOM BOW* on menu R8 and then press **ENTER**.

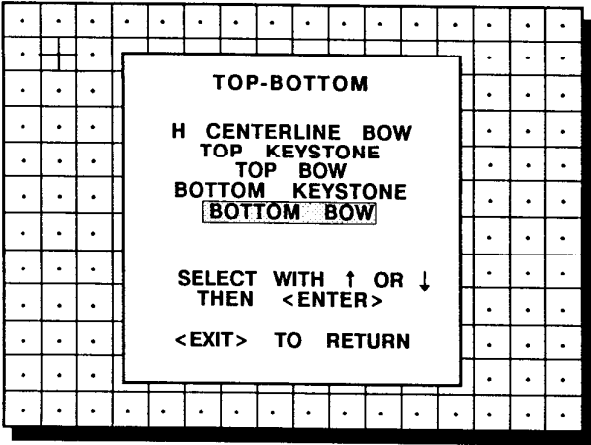

menu R8

<ENTER> will select bottom bow adjustment
 <EXIT> will return to Geometry menu (Menu R4)
 <ADJUST> returns to operational mode

Use the up and down arrow key to adjust the bottom bow in the lower part of the setup pattern. Adjust until the horizontal lines are straight. A bar scale and a number indicator give a visual indication of the adjustment.

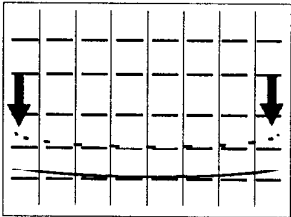
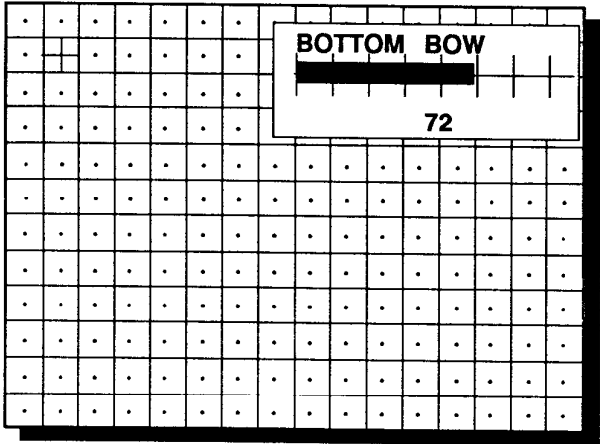

Correct with down arrow key

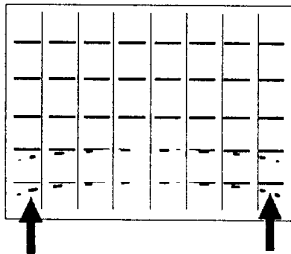

Correct with up arrow key

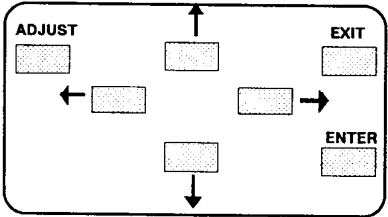

<ENTER> will return to Top-Bottom adjustment menu (Menu R8)
 <EXIT> will return to Geometry menu (Menu R4)

RANDOM ACCESS ADJUSTMENT MODE

Horizontal Size Adjustment

Use the arrow keys to highlight *H SIZE* on menu R4 and then press **ENTER**.

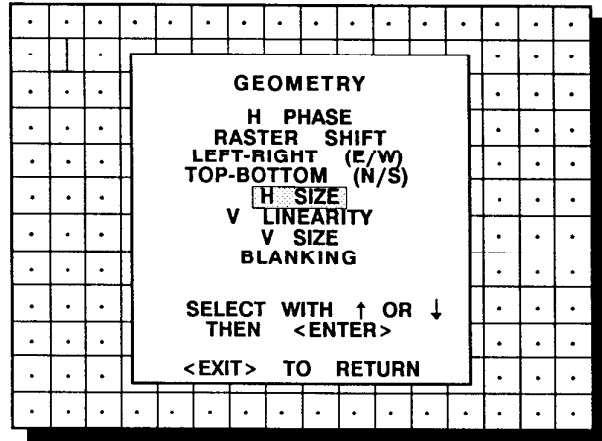

menu R4

<ENTER> will select horizontal size adjustment
 <EXIT> will return to Geometry-Converge menu (Menu R3)
 <ADJUST> returns to operational mode

Adjust the horizontal size with the left and right arrow key until the exact image width is obtained.

Therefore :

- if the internal # pattern was selected, this pattern remains on the screen.
- if the genlocked pattern was selected, the external source will be displayed.

A bar scale and a number indicator give a visual indication of the horizontal size adjustment.

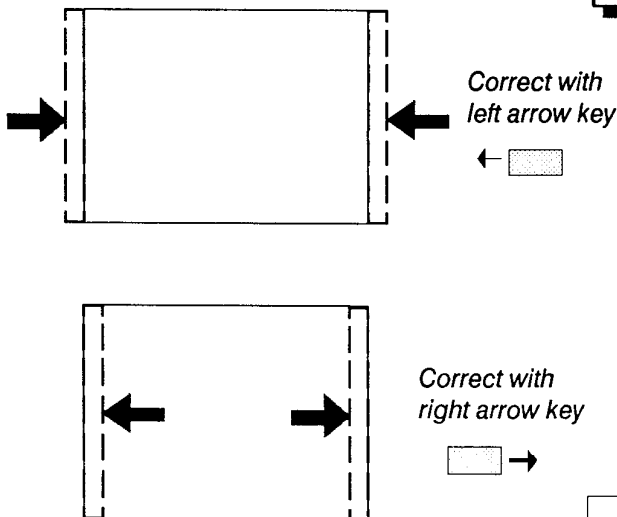
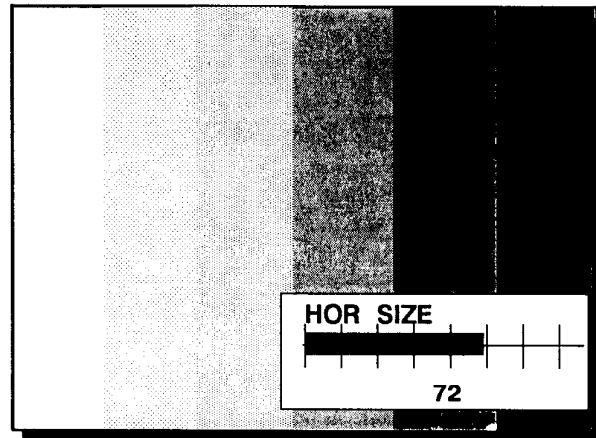

Hint : In order to avoid loss of resolution in the projected image and to ensure maximum CRT longevity, do not use an excessively small horizontal size setting.

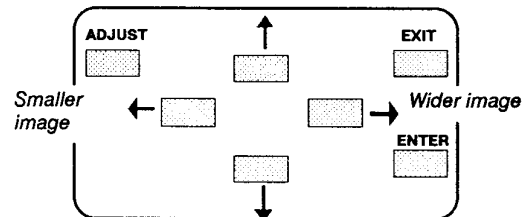

<EXIT> will return to Geometry (Menu R4)

RANDOM ACCESS ADJUSTMENT MODE

Vertical Linearity Adjustment

Use the arrow keys to highlight **VLINEARITY** on menu R4 and then press **ENTER**.

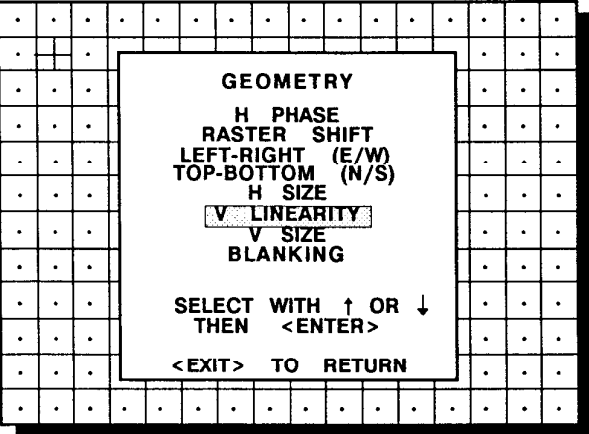

menu R4

<ENTER> will select vertical linearity adjustment
 <EXIT> will return to Geometry-Converge menu (Menu R3)
 <ADJUST> returns to operational mode

Adjust the vertical linearity with the arrow keys until the distances between the horizontal lines of the set up pattern are equal.

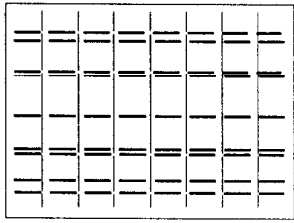
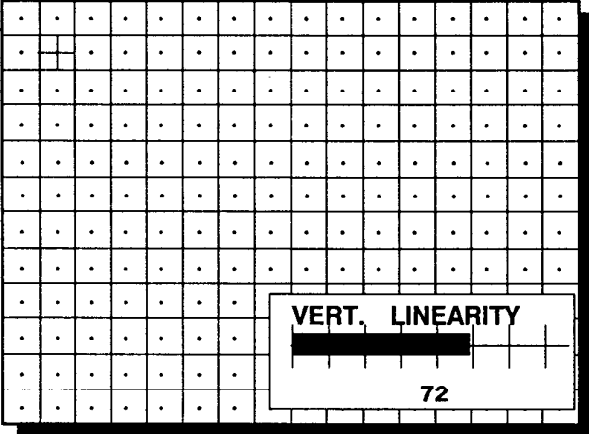

Correct with up arrow key
 ↑

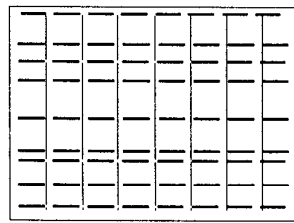

Correct with down arrow key
 ↓

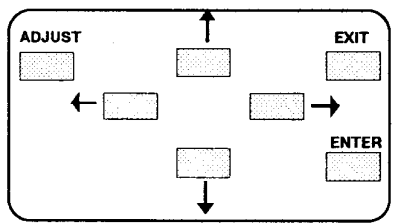

<EXIT> will return to Geometry (Menu R4)

RANDOM ACCESS ADJUSTMENT MODE

Vertical Size Adjustment

Use the arrow keys to highlight *V SIZE* on menu R4 and then press **ENTER**.

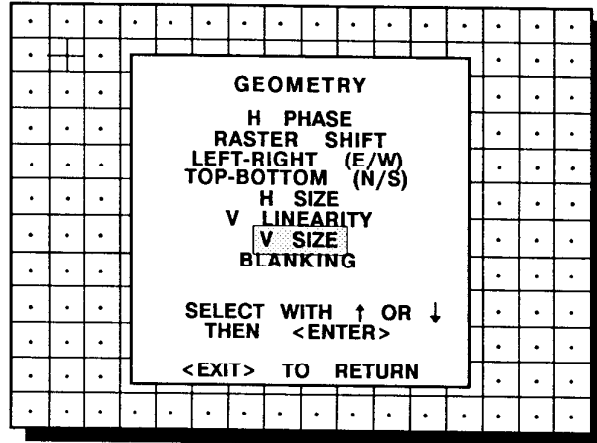

Menu R4

Adjust the vertical size with the up or down arrow key until the exact image height is obtained. Therefore :

- if the internal # pattern was selected, this pattern remains on the screen.
- if the genlocked pattern was selected, the external source will be displayed.

A bar scale and a number indicator give a visual indication of the vertical size adjustment.

Hint : In order to avoid loss of resolution in the projected image and to ensure maximum CRT longevity, do not use an excessively small vertical size setting.

<ENTER> will select vertical size adjustment
 <EXIT> will return to Geometry-Converge menu (Menu R3)
 <ADJUST> returns to operational mode

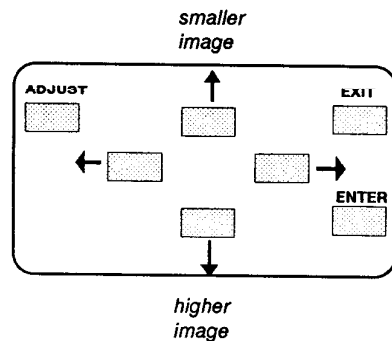
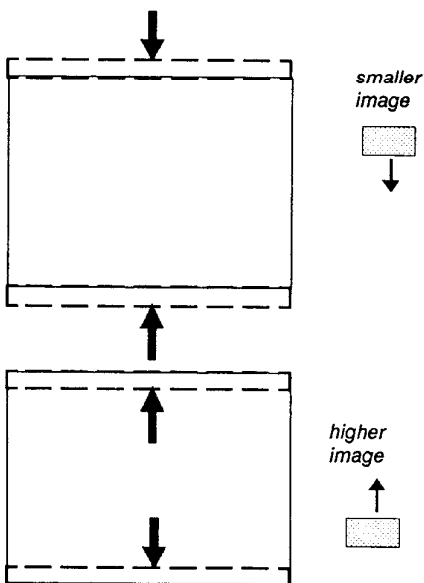
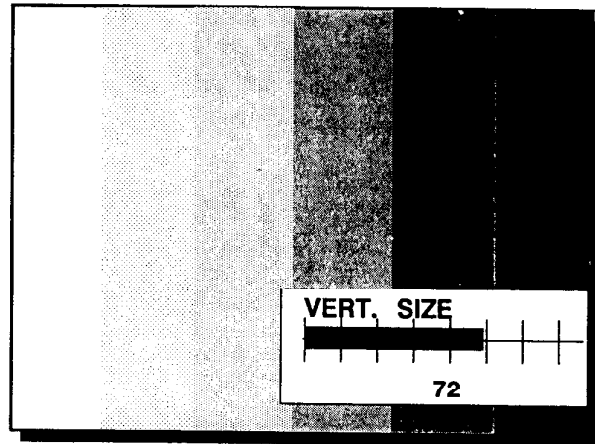

<EXIT> will return to Geometry (Menu R4)

RANDOM ACCESS ADJUSTMENT MODE

Blanking Adjustments

Use the arrow keys to highlight *BLANKING* on menu R4 and then press **ENTER**.

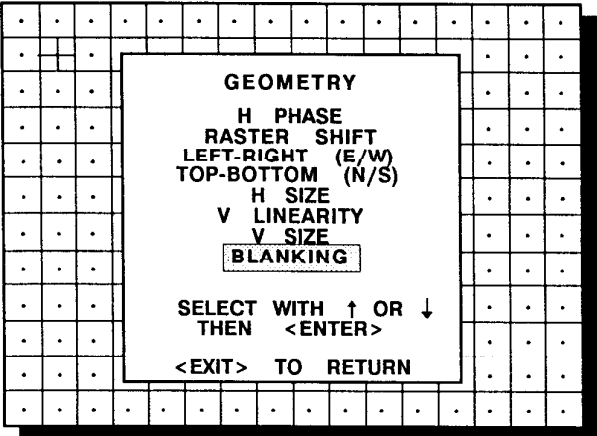

menu R4

<ENTER> will select blanking adjustment menu (Menu R8)
 <EXIT> will return to Geometry-Converge menu (Menu R3)
 <ADJUST> returns to operational mode

Blanking adjustments affect only the edges of the projected image and are used to frame the projected image on to the screen. The following blanking corrections are possible :

- top blanking
- bottom blanking
- left blanking
- right blanking

Therefore :

- if the internal # pattern was selected, this pattern remains on the screen.
- if the genlocked pattern was selected, the external source will be displayed.

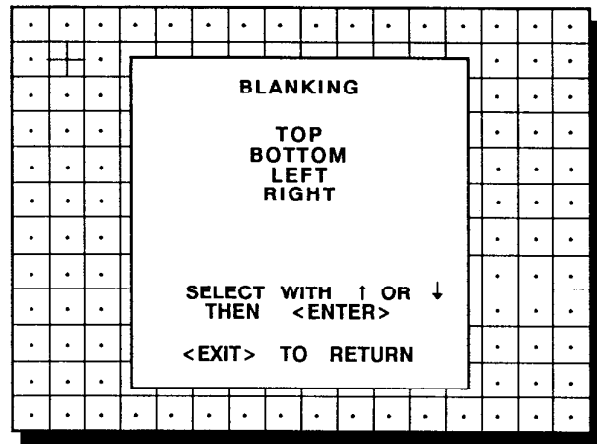

menu R9

<EXIT> will return to Geometry (Menu R4)
 <ADJUST> returns to operational mode

RANDOM ACCESS ADJUSTMENT MODE

Top Blanking Adjustment

Use the arrow keys to highlight *TOP* on menu R9 and then press **ENTER**.

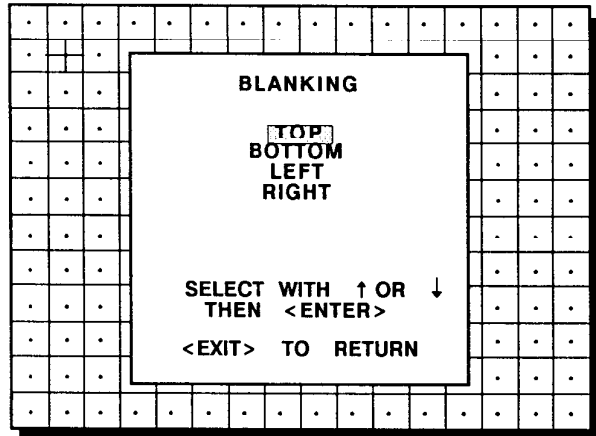

menu R9

<ENTER> will select top blanking adjustment
 <EXIT> will return to Geometry menu (Menu R4)
 <ADJUST> returns to operational mode

Use the arrow keys to adjust the top blanking. Press **ENTER** to continue

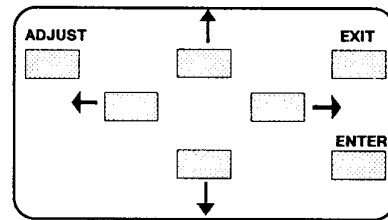
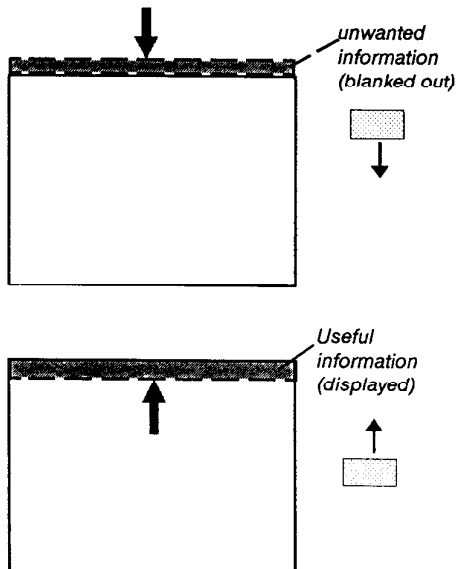
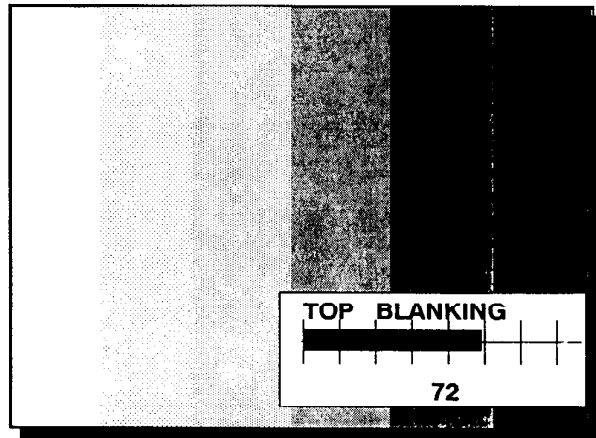

<EXIT> will return to Blanking (Menu R9)

RANDOM ACCESS ADJUSTMENT MODE

Bottom Blanking Adjustment

Use the arrow keys to highlight **BOTTOM** on menu R9 and then press **ENTER**.

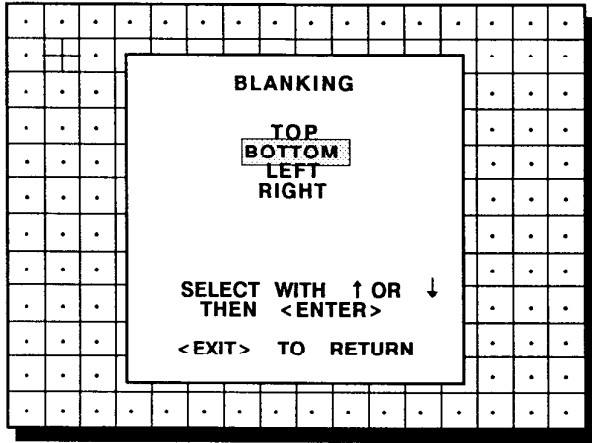

menu R9

<ENTER> will select bottom blanking adjustment
 <EXIT> will return to Geometry menu (Menu R4)
 <ADJUST> returns to operational mode

Use the arrow keys to adjust the top blanking. Press **ENTER** to continue

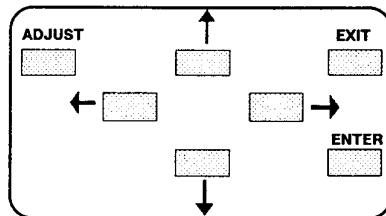
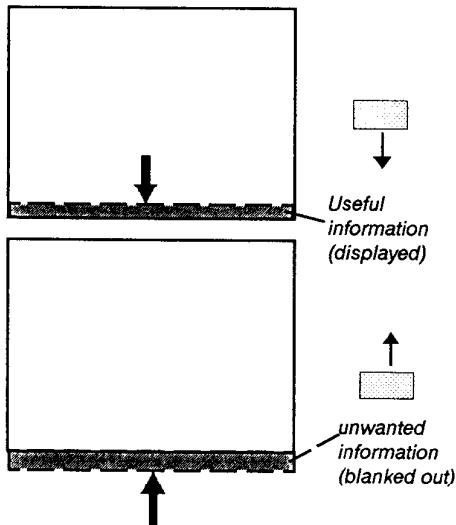
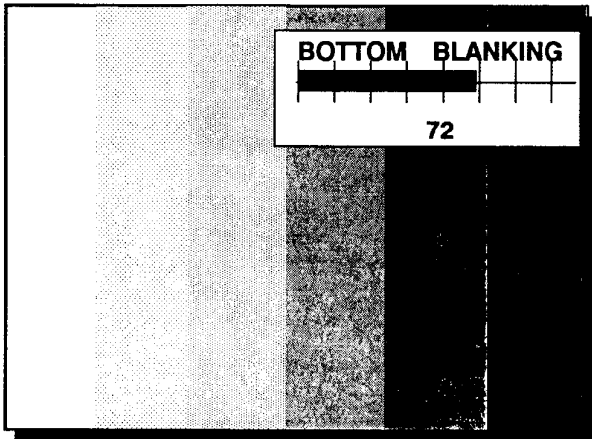

<EXIT> will return to Blanking (Menu R9)

RANDOM ACCESS ADJUSTMENT MODE

Left Blanking Adjustment

Use the arrow keys to highlight *LEFT* on menu R9 and then press **ENTER**.

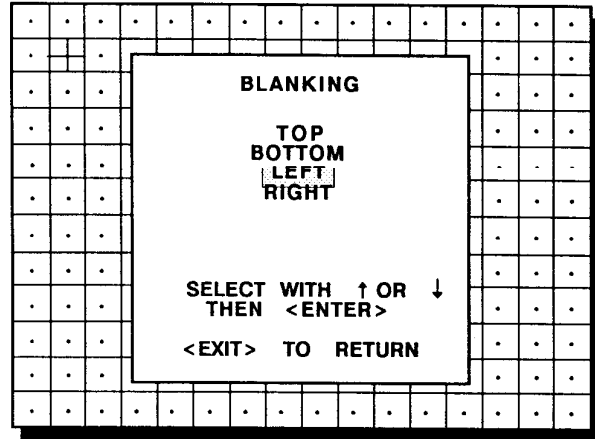

menu R9

<ENTER> will select left blanking adjustment
 <EXIT> will return to Geometry menu (Menu R4)
 <ADJUST> returns to operational mode

Use the arrow keys to adjust the left blanking. Press **ENTER** to continue

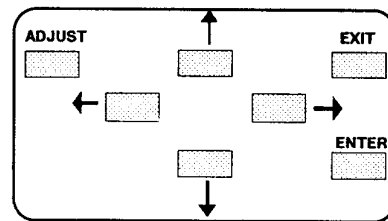
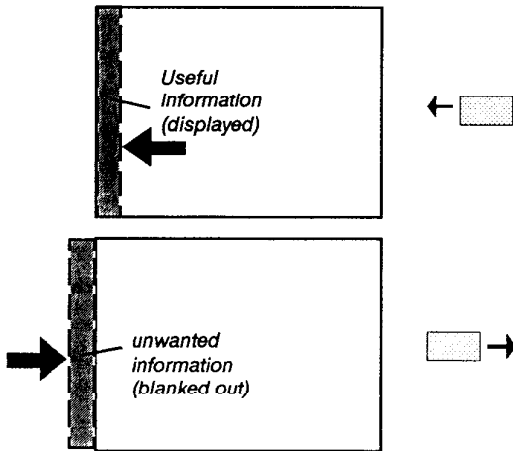
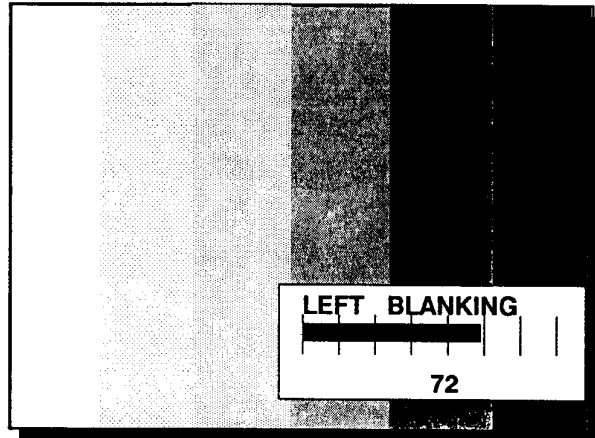

<EXIT> will return to Blanking (Menu R9)

RANDOM ACCESS ADJUSTMENT MODE

Right Blanking Adjustment

Use the arrow keys to highlight *RIGHT* on menu R9 and then press **ENTER**.

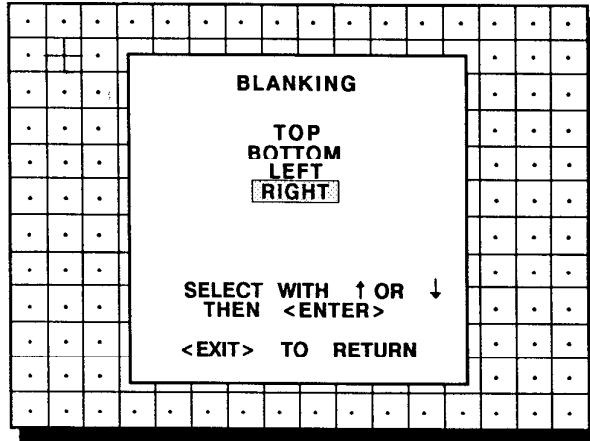

menu R9

<ENTER> will select right blanking adjustment
 <EXIT> will return to Geometry menu (Menu R4)
 <ADJUST> returns to operational mode

Use the arrow keys to adjust the right blanking. Press **ENTER** to continue

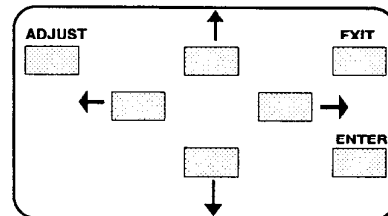
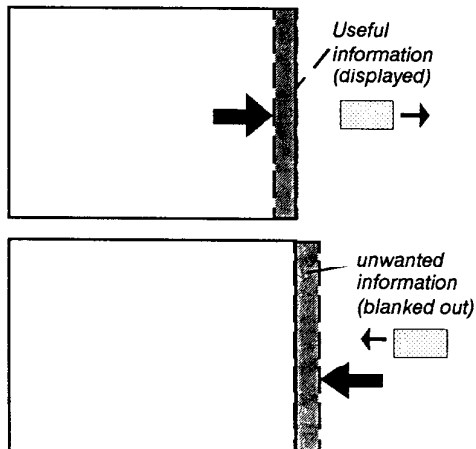
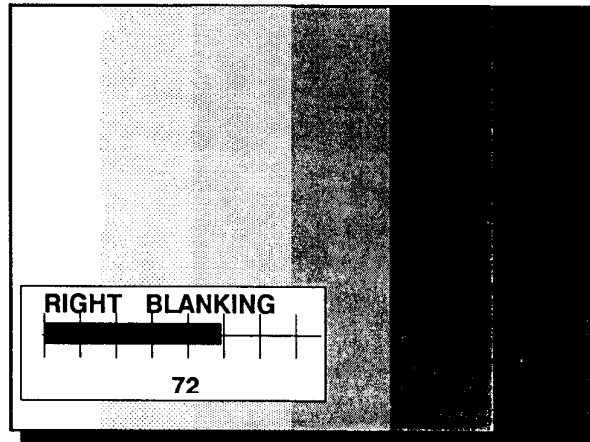

<EXIT> will return to Blanking (Menu R9)

RANDOM ACCESS ADJUSTMENT MODE

Red or Blue on Green Geometry Adjustments

Highlight *RED ON GREEN* or *BLUE ON GREEN* under *GEOMETRY* with the arrow keys and press **ENTER** to display menu R5.

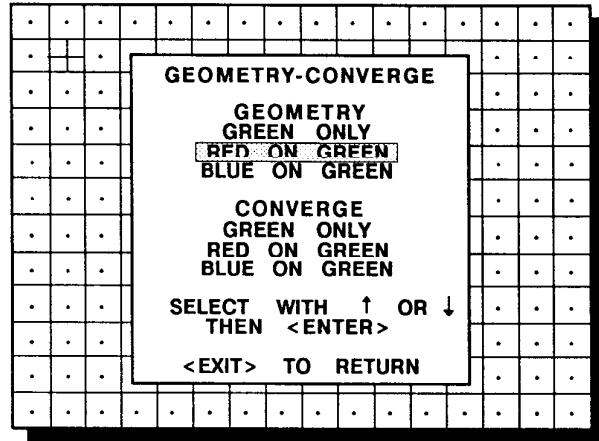

menu R3

<ENTER> will display Geometry menu (Menu R5)
 <EXIT> will return to Random Access Adjustment Mode main menu (Menu R1)
 <ADJUST> returns to operational mode

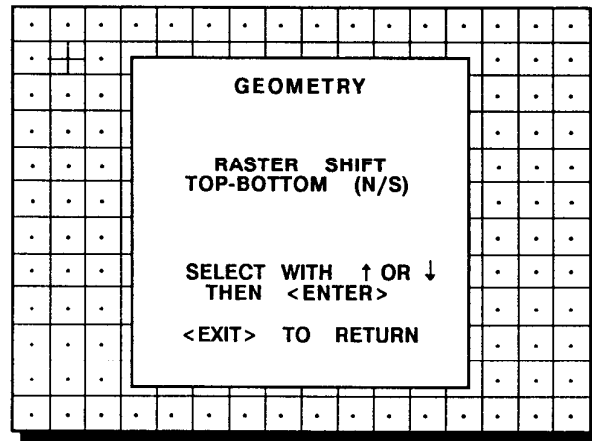

menu R5

<EXIT> will return to Geometry-Converge menu (Menu R3)

RANDOM ACCESS ADJUSTMENT MODE

Red or Blue Raster Shift Adjustment

Use the arrow keys to highlight *RASTER SHIFT* on menu R5 and then press **ENTER**.

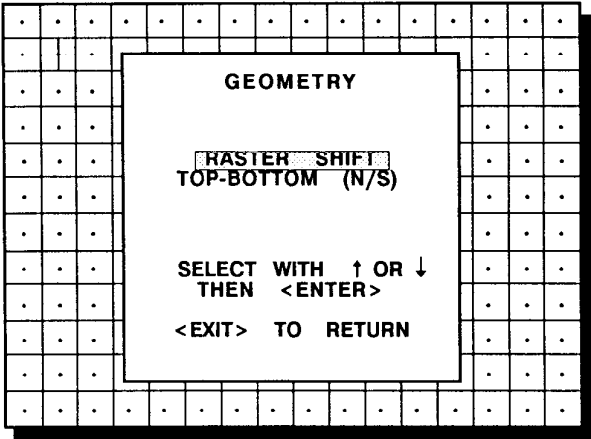

menu R5

<ENTER> will select red or blue raster shift adjustment
 <EXIT> will return to Geometry-Converge menu (Menu R3)
 <ADJUST> returns to operational mode

Shift the Red or Blue raster with the arrow keys until this image coincides with the green image.

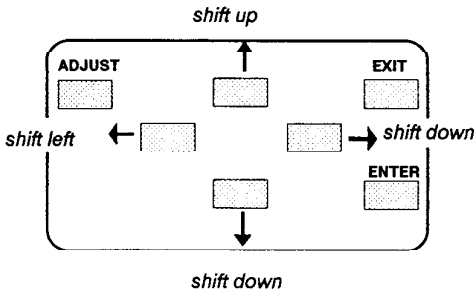
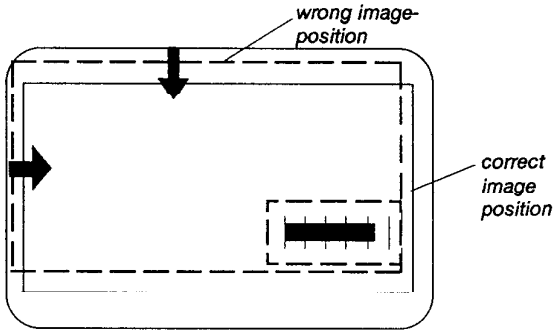
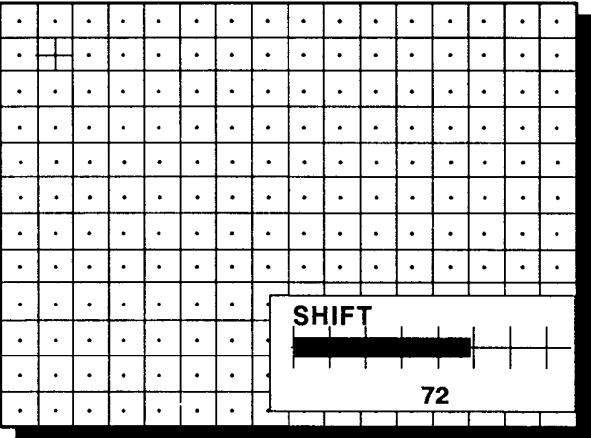

<EXIT> will return to Geometry (Menu R5)

RANDOM ACCESS ADJUSTMENT MODE

Top-Bottom (north-south) Adjustments

Top-Bottom adjustments affect only the horizontal lines of the projected image. Convergence corrections are automatically disabled for the duration of these adjustments.

Use the arrow keys to highlight *TOP-BOTTOM (N/S)* on menu R5 and then press **ENTER**.

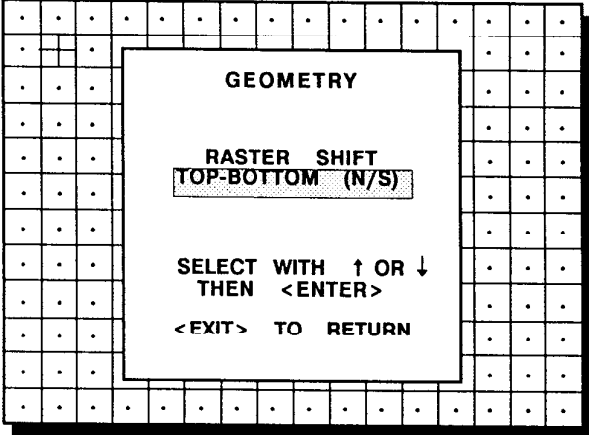

menu R5

- <ENTER> will select Top-Bottom adjustment menu (Menu R8)
- <EXIT> will return to Geometry-Converge menu (Menu R3)
- <ADJUST> returns to operational mode

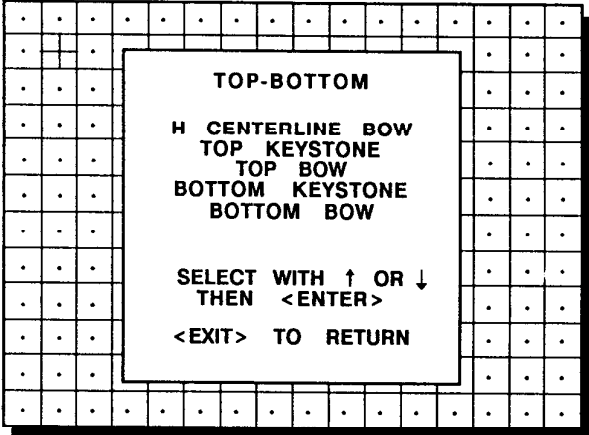

menu R8

- <EXIT> will return to Geometry (Menu R5)

RANDOM ACCESS ADJUSTMENT MODE

Horizontal Centerline Bow Adjustment

Use the arrow keys to highlight **H CENTERLINE BOW** on menu R8 and then press **ENTER**.

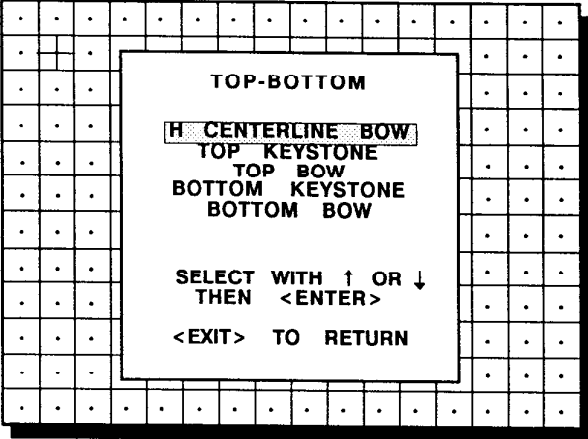

menu R8

<ENTER> will select horizontal centerline bow adjustment
 <EXIT> will return to Geometry menu (Menu R5)
 <ADJUST> returns to operational mode

Use the up and down arrow key to adjust the horizontal centerline bow of the setup pattern. A bar scale and a number indicator will give a visual indication of the bow correction.

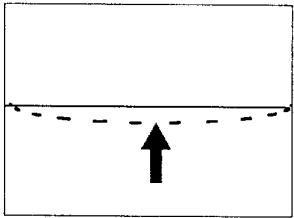
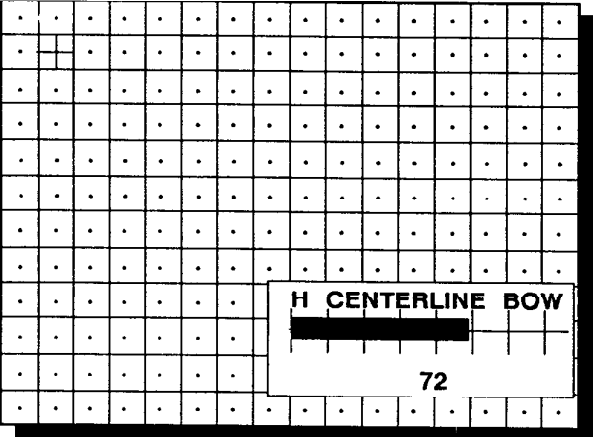

Correct with up arrow key

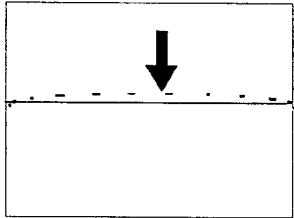

Correct with down arrow key

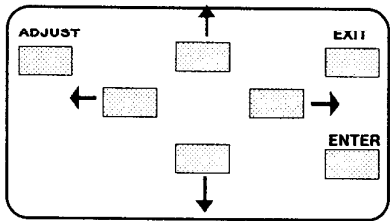

<ENTER> will return to Top-Bottom adjustment menu (Menu R8)
 <EXIT> will return to Geometry menu (Menu R5)

RANDOM ACCESS ADJUSTMENT MODE

Top Keystone Adjustment

Use the arrow keys to highlight *TOP KEYSTONE* on menu R8 and then press **ENTER**.

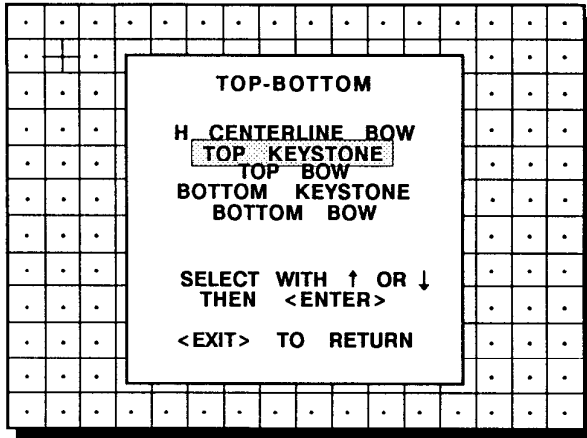

menu R8

<ENTER> will select top keystone adjustment
 <EXIT> will return to Geometry menu (Menu R5)
 <ADJUST> returns to operational mode

Adjust the horizontal lines in the upper part of the picture with the arrow keys until these lines are straight. Press **ENTER** to continue.

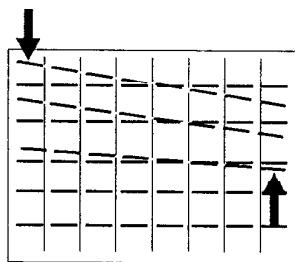
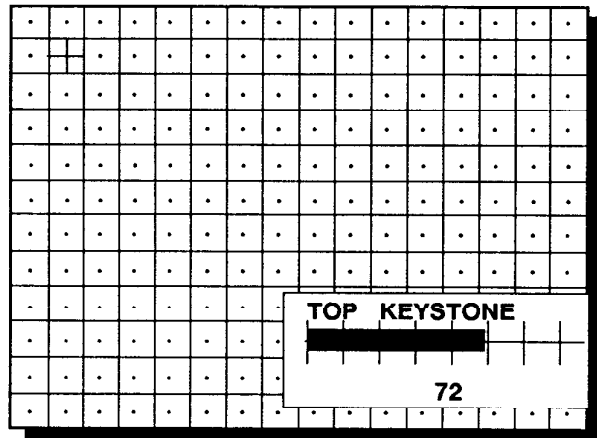

Correct with up arrow key

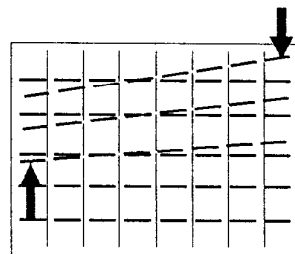

Correct with down arrow key

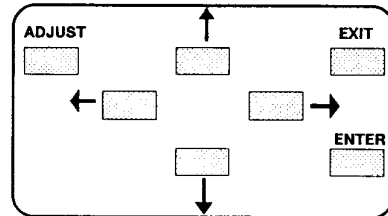

<ENTER> will return to Top-Bottom adjustment menu (Menu R8)
 <EXIT> will return to Geometry menu (Menu R5)

RANDOM ACCESS ADJUSTMENT MODE

Top Bow Adjustment

Use the arrow keys to highlight *TOP BOW* on menu R8 and then press **ENTER**.

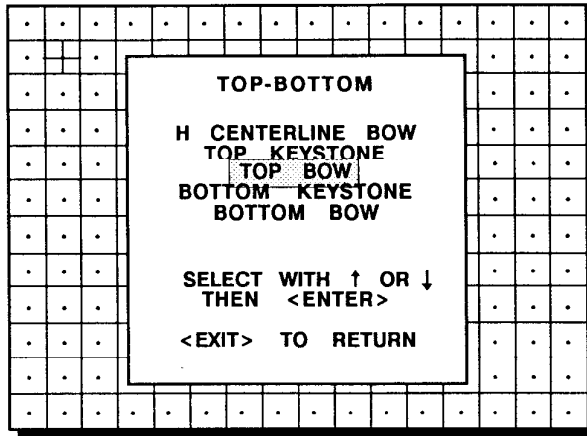

menu R8

<ENTER> will select top bow adjustment
 <EXIT> will return to Geometry menu (Menu R5)
 <ADJUST> returns to operational mode

Adjust the bow of the horizontal lines in the upper side of the image with the arrow keys until these lines are straight. A bar scale and a number indicator indicates the amount of adjustment.

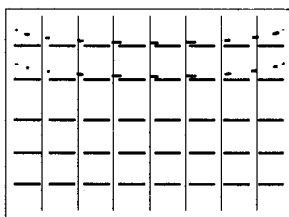
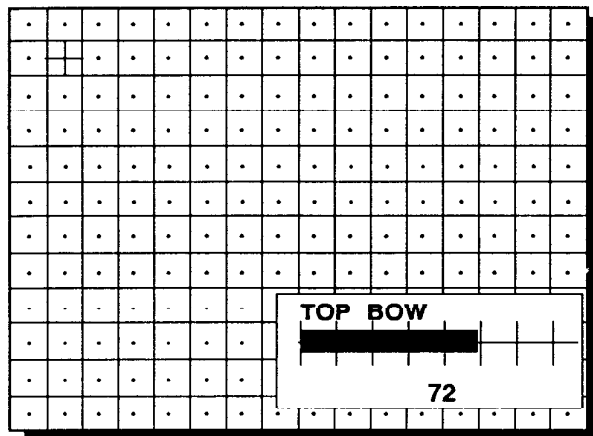

Correct with
down arrow key

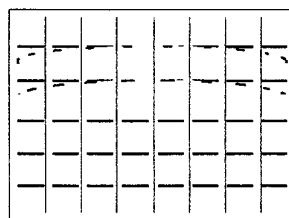

Correct with up
arrow key

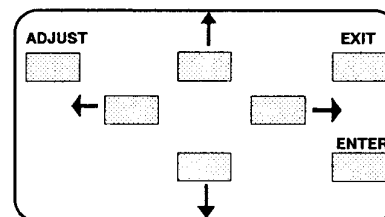

<ENTER> will return to Top-Bottom adjustment menu (Menu R8)
 <EXIT> will return to Geometry menu (Menu R5)

RANDOM ACCESS ADJUSTMENT MODE

Bottom Keystone Adjustment

Use the arrow keys to highlight **BOTTOM KEYSTONE** on menu R8 and then press **ENTER**.

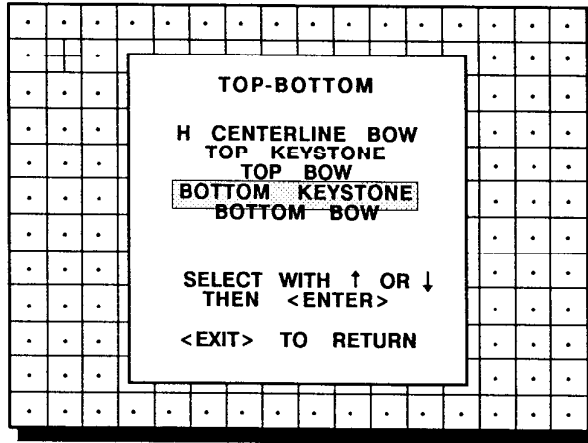

menu R8

<ENTER> will select bottom keystone adjustment
 <EXIT> will return to Geometry menu (Menu R5)
 <ADJUST> returns to operational mode

Adjust the horizontal lines in the lower part of the image with the arrow keys until these lines are straight. A bar scale and a number indicator (between 0 and 100) will give a visual indication of the adjustment.

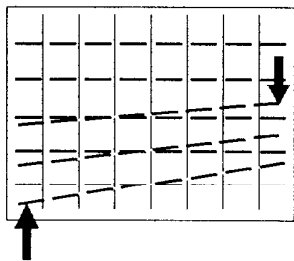
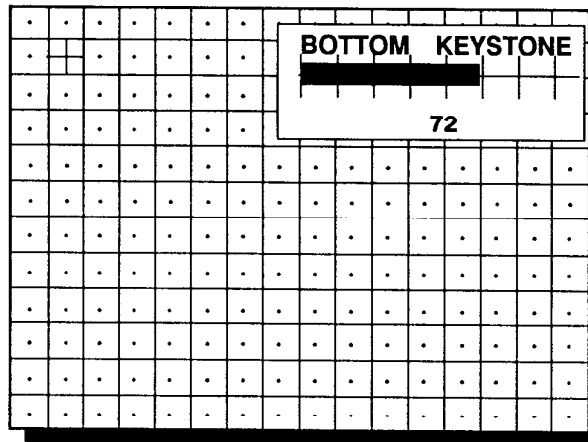

Correct with down arrow key

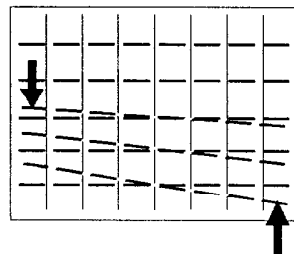

Correct with up arrow key

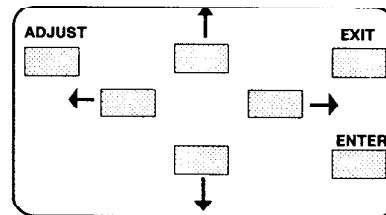

<ENTER> will return to Top-Bottom adjustment menu (Menu R8)
 <EXIT> will return to Geometry menu (Menu R5)

RANDOM ACCESS ADJUSTMENT MODE

Bottom Bow Adjustment

Use the arrow keys to highlight *BOTTOM BOW* on menu R8 and then press **ENTER**.

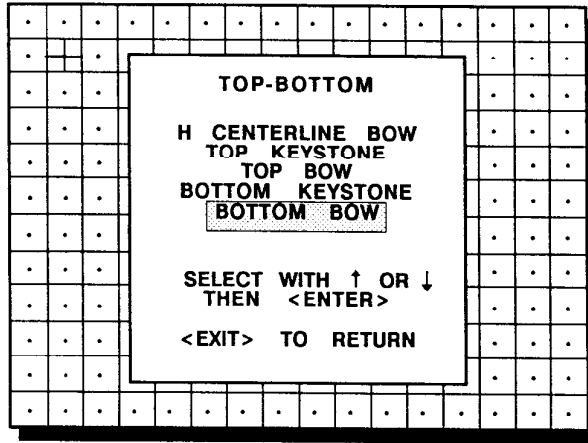

menu R8

<ENTER> will select bottom bow adjustment
 <EXIT> will return to Geometry menu (Menu R5)
 <ADJUST> returns to operational mode

Adjust the horizontal lines in the lower part of the image with the arrow keys until these lines are straight. A bar scale and a number indicator (between 0 and 100) will give a visual indication of the adjustment.

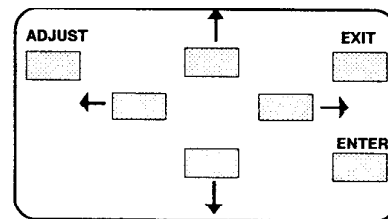
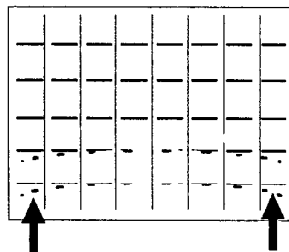
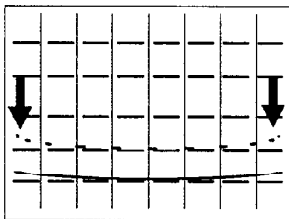
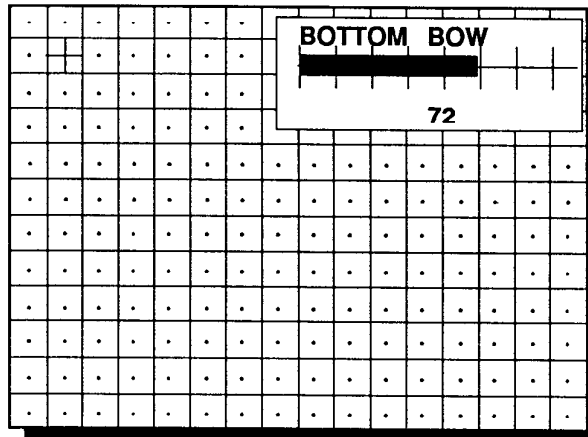

<ENTER> will return to Top-Bottom adjustment menu (Menu R8)
 <EXIT> will return to Geometry menu (Menu R5)

RANDOM ACCESS ADJUSTMENT MODE

Red or Blue on Green Convergence Adjustments

Highlight *RED ON GREEN* or *BLUE ON GREEN* under *CONVERGENCE* with the arrow keys and press **ENTER** to display menu R6.

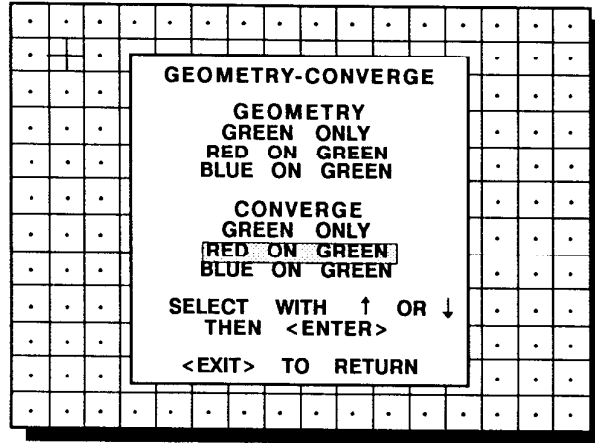

menu R3

<ENTER> will display Convergence menu (Menu R6)
<EXIT> will return to Random Access Adjustment Mode main menu (Menu R1)
<ADJUST> returns to operational mode

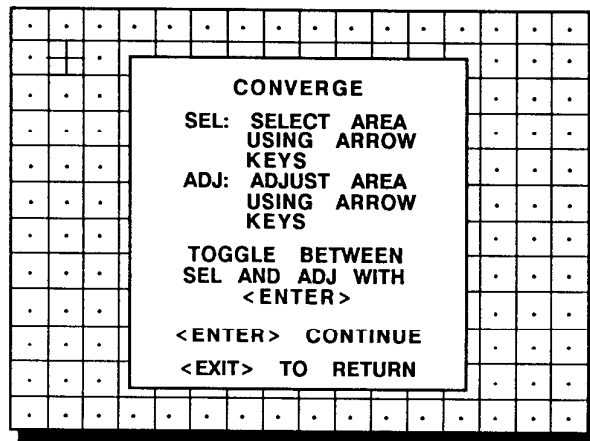

menu R6

<ENTER> will continue to convergence adjustment
<EXIT> will return to Geometry-Converge menu (Menu R3)

RANDOM ACCESS ADJUSTMENT MODE

The projected image is divided into 25 convergence zones. Use the arrow keys to move the box to the desired zone and then press **ENTER** to begin the convergence adjustment. Start the convergence adjustment with zone one and continue as mentioned in the diagram hereafter.

25	23	9	15	17
24	22	8	14	16
5	4	1	2	3
20	18	6	10	12
21	19	7	11	13

Use the arrow keys to make horizontal or vertical convergence adjustments in the selected zone and then press **ENTER** to move the box to another zone or **EXIT** to return to the Geometry-Converge menu (Menu R3).

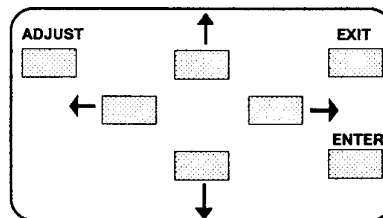
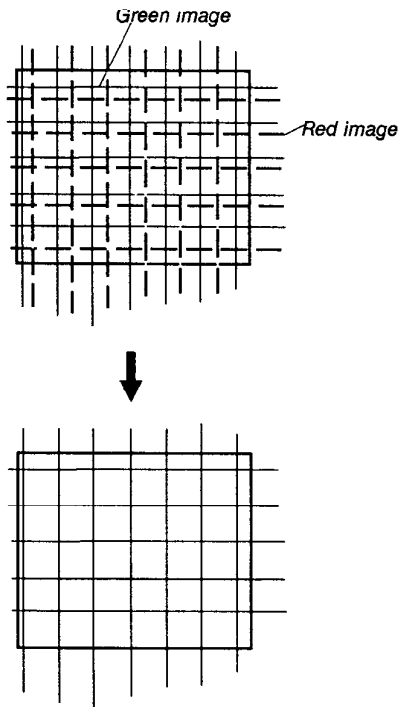
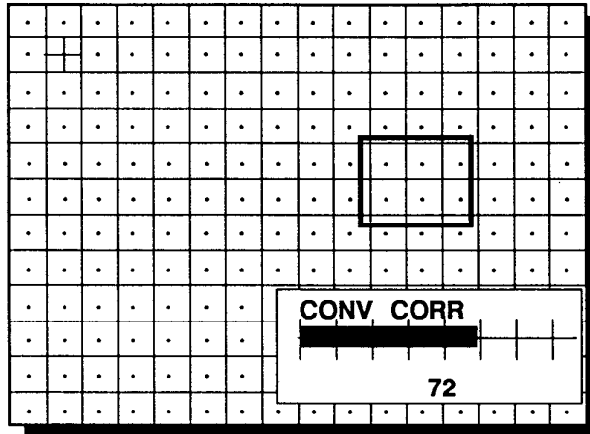

<ENTER> toggles arrow keys between zone selection and zone adjustment
 <EXIT> returns to Geometry-Converge menu (Menu R3)

RANDOM ACCESS ADJUSTMENT MODE

Notes

SERVICE MODE

SERVICE MODE

- START UP SCREEN
- COPY A BLOCK (*)
- DELETE A BLOCK
- DELETE ALL BLOCKS
- CHANGE PASSWORD
- RUN TIME
- SET TO MITPOSITION
- CONVERGENCE OFF(**)

(*) for software version 2.04 and higher
(**) for software version 2.03 and higher.

SERVICE MODE

Starting up the service mode.

Use the arrow keys on the RCU800 to highlight 'Service' and then press ENTER.

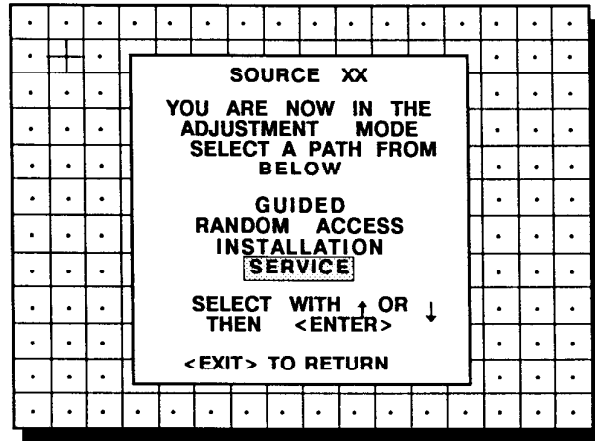

menu S1

<ENTER> continues to service mode, menu SE1.
<EXIT> returns to operational mode.

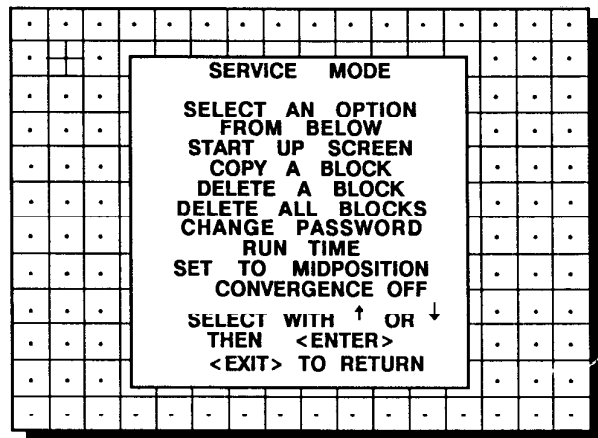

menu SE1

SERVICE MODE

Overview flow chart 'Service' mode.

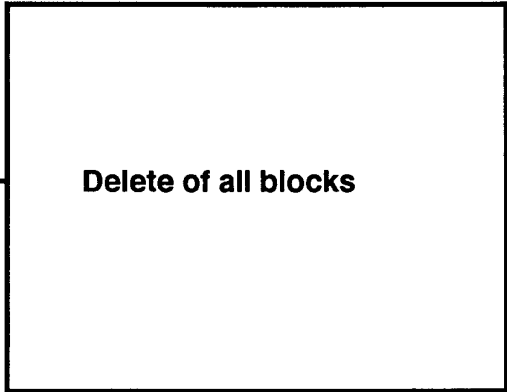
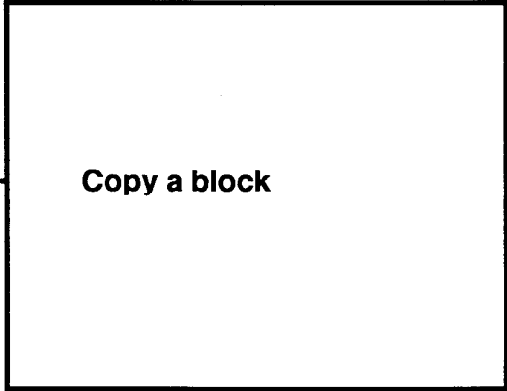
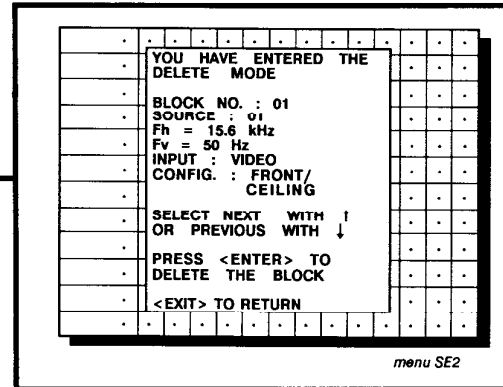
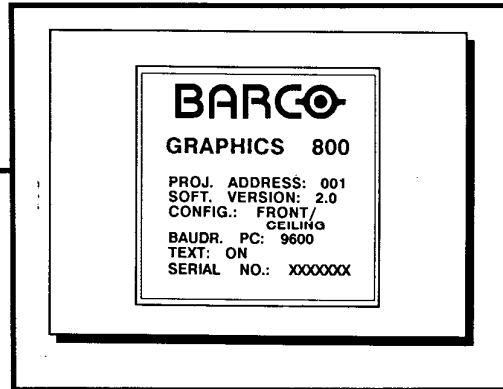
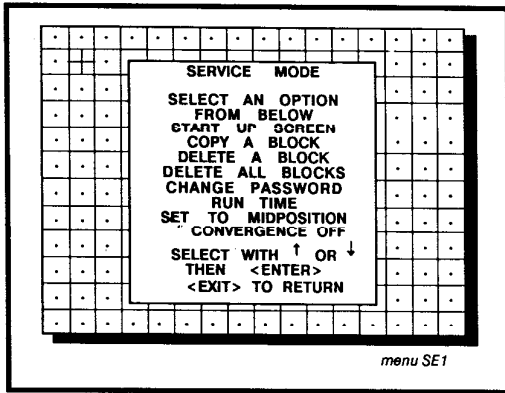

SERVICE MODE

PASSWORD

ENTER NEW PASSWORD:
1990

USE THE ARROW KEYS
TO SELECT OR
PROGRAM WITH
NUMERIC KEYS

<ENTER> TO CONFIRM
<EXIT> TO RETURN

RUN TIME
0105 h

Set to midposition

Convergence off

SERVICE MODE

Start up screen.

Highlight 'Start up screen' with the arrow keys and press ENTER.

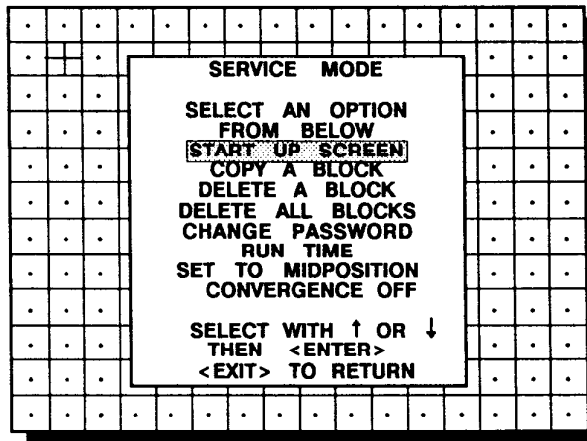

menu SE1

<ENTER> will start the selected item.
<EXIT> returns to the path selection menu, menu S1.

The 'Start up' screen gives information concerning :

- projector address. To change the address of your projector, contact a qualified service technician.
- software version.
- configuration.
 - possible installations :
 - * front-ceiling
 - * front-table
 - * rear-ceiling
 - * rear-table

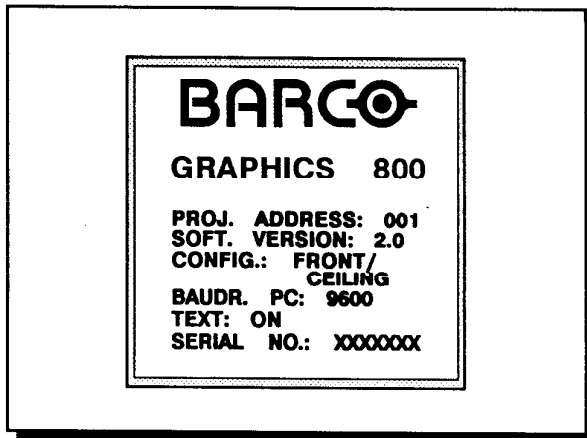

BARCO start up screen

- baudrate PC : transfer speed for communication with a IBM PC (or compatible) or MAC. The baudrate of the projector must be the same as the baudrate of the connected computer. When there is a difference, contact a qualified service technician to change.
- Text ON/OFF

Indicates in operational mode if the bar scale and number indicator will be displayed and if warnings and failures will be displayed to.

ON : displayed
OFF : not displayed

The status can be changed when pressing once on the 'text' key of the RCU800.
- Serial no. : indicates the fabrication number of the projector. This number can be useful when calling for technical assistance.

SERVICE MODE

Copy a block

To copy the settings of a closed block to the block you are working on. All existing setting will be overwritten with the new settings.

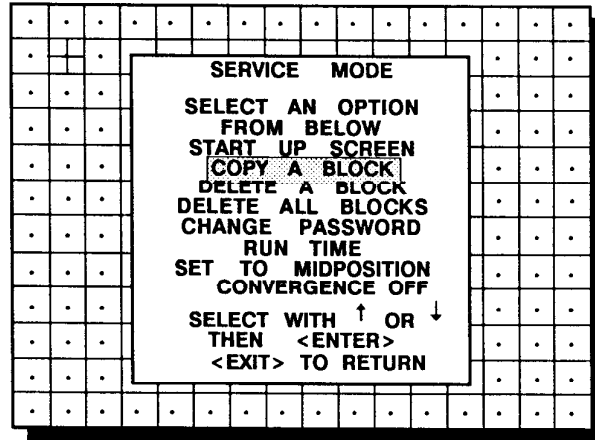

menu SE1

<ENTER> will select the pointed item.
<EXIT> returns to the path selection menu, menu S1.

A first block header will be displayed in menu SE6.

To select the desired block :

1. Use the up and down arrow keys on the RCU800 to scroll through the adjustment blocks. The contents of each block header are displayed on the copy menu, menu SE6.
2. Press **ENTER** to copy the selected adjustment block. A 'confirm' screen appear on the screen.
3. If you are sure to copy the block, press **ENTER**.
Exit returns without copy the block.

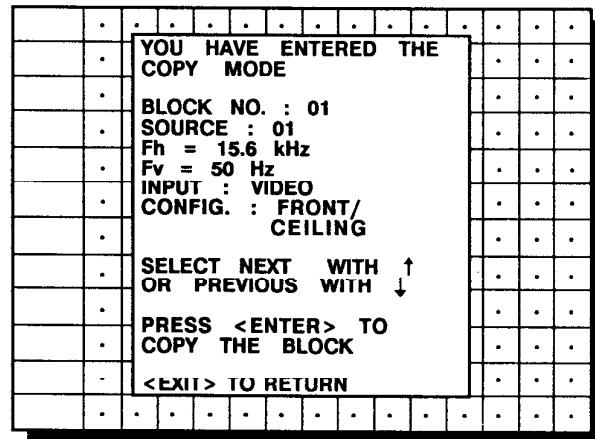

menu SE2

SERVICE MODE

Delete of blocks

The delete function is used to clear all data (settings) from an adj. block (see appendix B for explanation about 'adjustment blocks')

A delete can be given :

- block per block
- or
- for all blocks.

Deleting block per block

Highlights 'Delete a block' with the arrow keys and press ENTER.

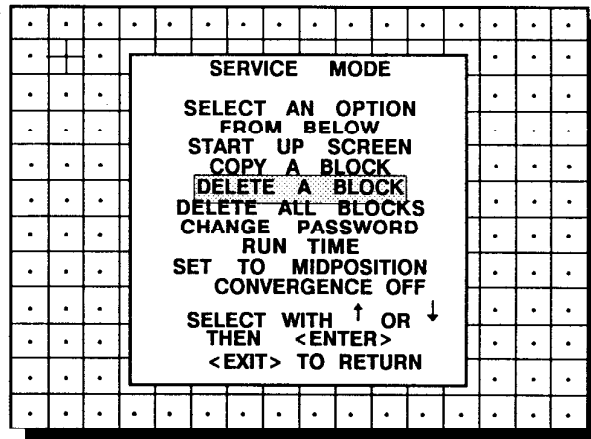

menu SE1

<ENTER> will select the pointed item.
<EXIT> returns to the path selection menu, menu S1.

A first block header will be displayed in menu SE3.

To select the desired block :

1. Use the up and down arrow keys on the RCU800 to scroll through the adjustment blocks. The contents of each block header are displayed on the delete menu, menu SE2.
2. Press **ENTER** to delete the selected adjustment block. A 'confirm' screen appear on the screen.

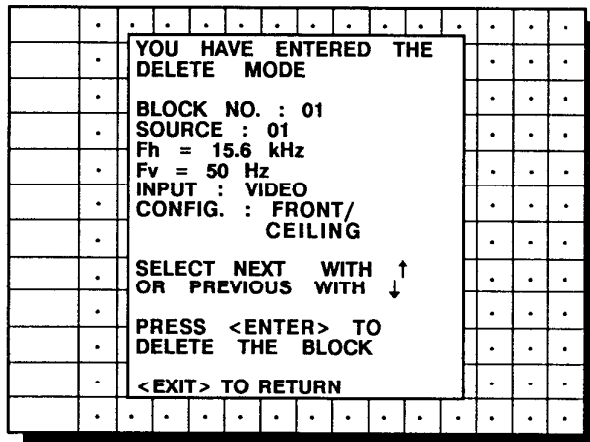

menu SE2

SERVICE MODE

3. If you are sure to delete the block, press **ENTER**. The deleted block number returns but all fields are blanked. *Once ENTER is pressed, the block header and adjustment settings are definitely removed and*

< ENTER >
to confirm

< EXIT >
to return

**block is
deleted**

4. If another block has to be deleted, use the up and down arrow keys to scroll through the adjustment blocks and repeat the delete procedure as above. Otherwise, press **EXIT** to return to operational mode

.
.	YOU HAVE ENTERED THE DELETE MODE													.	.	.			
.	BLOCK NO. : 01 SOURCE : 01 Fh = 15.6 kHz Fv = 50 Hz INPUT : VIDEO CONFIG. : FRONT/ CEILING													.	.	.			
.	SELECT NEXT WITH ↑ OR PREVIOUS WITH ↓													.	.	.			
.	PRESS < ENTER > TO DELETE THE BLOCK													.	.	.			
.	< EXIT > TO RETURN													.	.	.			
.

menu SE2

< ENTER > selected block will be deleted.
< EXIT > returns to the service mode menu, menu SE1.
< ADJUST > returns to operational mode.

SERVICE MODE

Delete of all blocks

Highlights 'delete all blocks' with the arrow keys on the RCU800 and press **ENTER**.

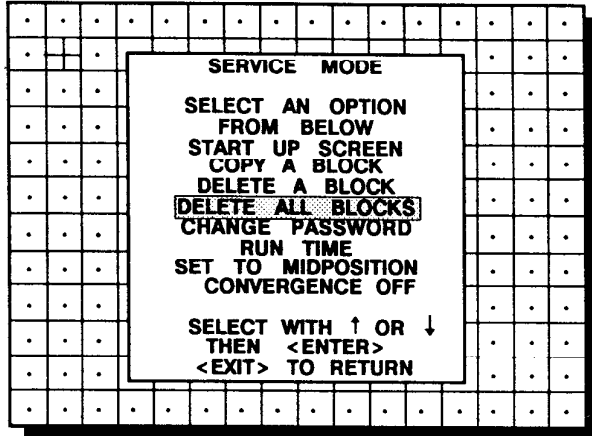

menu SE1

<ENTER> gives a confirmation message before deleting.
<EXIT> returns to the path selection menu, menu S1.
<ADJUST> returns to operational mode.

If you are sure to delete all blocks, press **ENTER** to confirm, otherwise press **EXIT** to return.
Once **ENTER** is pressed, all block headers and adjustment settings are definitely removed and cannot be restored.

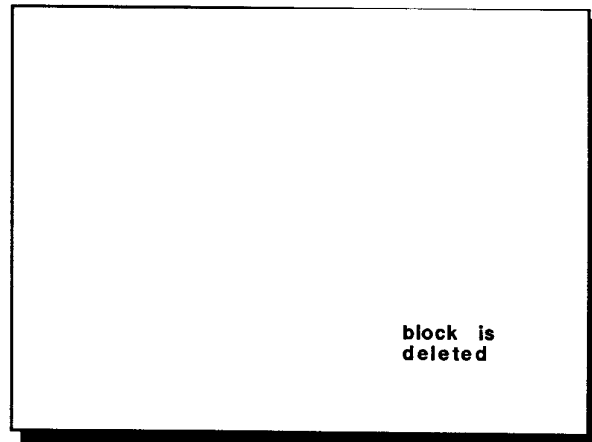
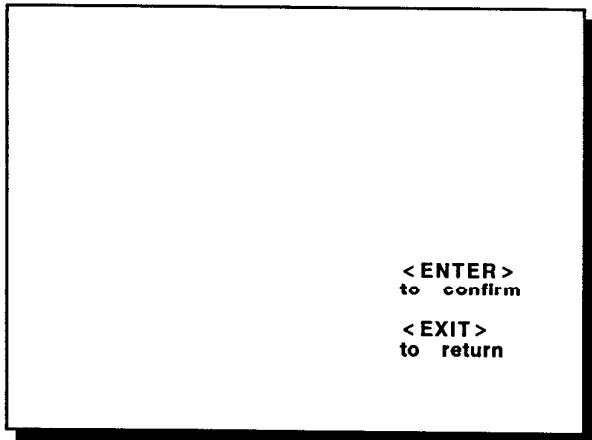

SERVICE MODE

Change password

Highlights 'change password' with the arrow keys and press ENTER.

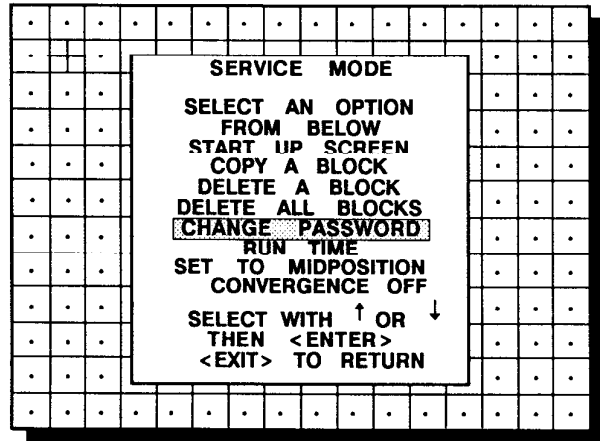

menu SE1

<ENTER> will display the selected item.
 <EXIT> will returns to the path selection menu, menu S1.
 <ADJUST> will returns to operational mode.

The current password is displayed. The new password must consist of 4 digits between 0 and 9. Use the arrow keys on the RCU800 to select the digits to be changed. Use the numeric keys to enter the new digits. Press ENTER to save the new password and to return to the service menu, menu SE1. Press EXIT to return to the Service menu without saving the new password.

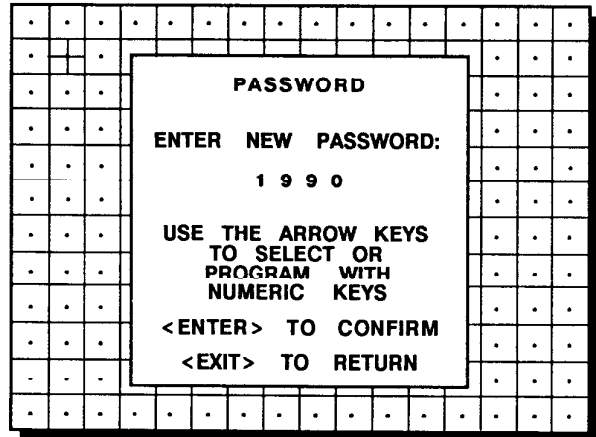

menu SE5

<ENTER> returns to service mode and saves the new password.
 <EXIT> returns to service mode without saving the new password.

SERVICE MODE

Run time

Highlights 'run time' with the arrow keys on the RCU800 and press ENTER to display the amount of time the projector is playing since its first start up at the factory.

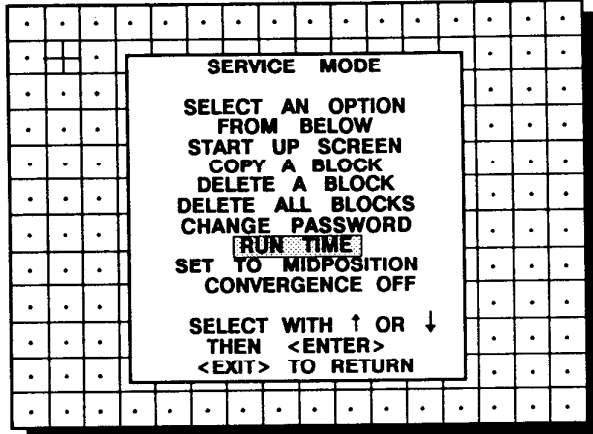

menu SE1

<ENTER> gives the selected item.
<EXIT> returns to the path selection menu, menu S1.
<ADJUST> returns to operational mode.

Note : all projectors leave the factory after a burn in periode of ± 100 hours.

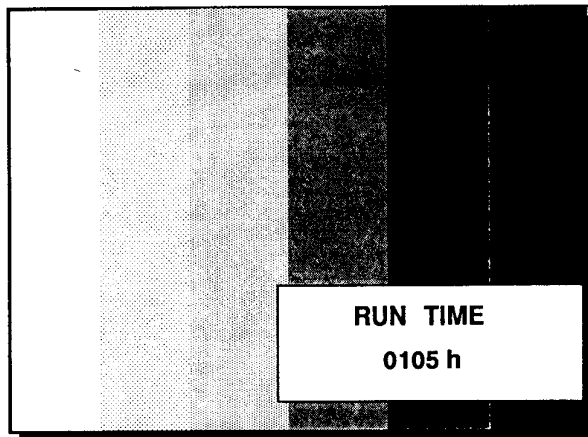

SERVICE MODE

Set to midposition

Highlights 'set to midposition' with the arrow keys and press ENTER to set all settings in their midposition.

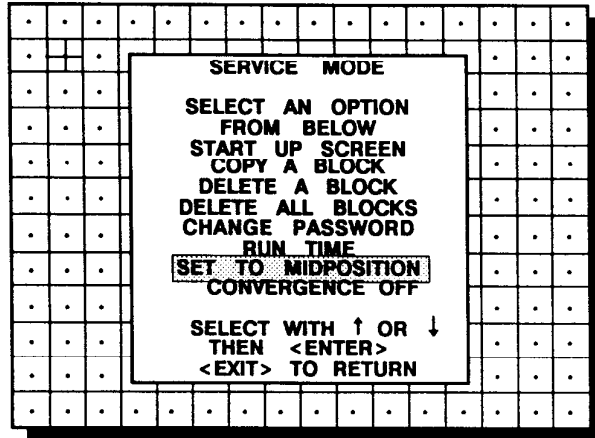

menu SE 1

<ENTER> sets all settings in their midposition.
<EXIT> returns to the path selection menu, menu S1
<ADJUST> returns to operational mode.

Convergence off

Highlights 'convergence off' with the arrow keys and press ENTER to set all convergence settings in their midposition.

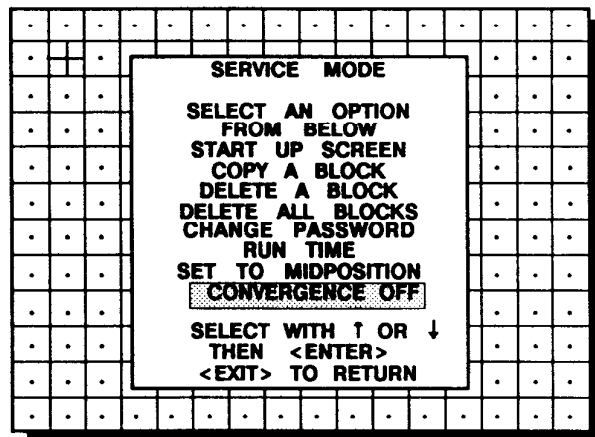

menu SE1

<ENTER> sets all convergence settings in their midposition.
<EXIT> returns to the path selection menu, menu S1
<ADJUST> returns to operational mode.

SPECIFICATIONS

SPECIFICATIONS

SPECIFICATIONS

I. RGB TTL circuit

Input : D9 connector, CGA and EGA compatible.

II. RGB(S) analog circuit

RGsB : for sync on Green or

RGBS : for separate sync, Hor and Vert sync or composite sync.

Input : 5 BNC connectors

Red : $0.7 \text{ Vpp} \pm 3 \text{ dB}$

Blue : $0.7 \text{ Vpp} \pm 3 \text{ dB}$

Green : $0.7 \text{ Vpp} \pm 3 \text{ dB}$

1 $\text{Vpp} \pm 3 \text{ dB}$ if sync on green

Vert sync : $1 \text{ Vpp} \pm 3 \text{ dB}$ or $4 \text{ Vpp} \pm 3 \text{ dB}$

Hor sync / comp. sync : $1 \text{ Vpp} \pm 3 \text{ dB}$ or $4 \text{ Vpp} \pm 3 \text{ dB}$

III. Deflection circuits

Vertical deflection

Frequency : from 45 Hz to 120 Hz

Retrace time : $< 200 \text{ us}$

Horizontal deflection

Frequency : from 15 kHz to 90 kHz

Retrace time : $< 2.5 \text{ us}$

IV. High voltage

Stabilized EHT : 34.7 kV

V. Power requirements

- 220 V ac to 240 V ac or 110 V ac internal switchable
- frequency independence between 40-100 Hz
- power consumption : 350 W

VI. Display

Projection tubes : - 8" high resolution square projection tubes

- liquid cooled system

- Red, Blue and Green CRT's

Lenses : high resolution F1.06 Hybrid lenses

Image format : 3 x 4

Image dimensions (standard version)

min : 120x80 cm (4x3 ft)

max : 600x450 cm (20x15 ft)

Throw distance : (see table)

SPECIFICATIONS

Max. light output : At 10% peak white : 825 lumen
At 20% peak white : 575 lumen

Screen application : flat, parabolic or cylindrical screen

Geometric distortion: $\pm 1\%$ in circle equal to image height, $\pm 1.5\%$ outside

Convergence : calibration using 25 Independent zones.

VII. Mechanical characteristics

Dimensions : see drawing on next page

VIII. Mounting

Table standard or ceiling; front or rear projection possibility.

Adaptation ceiling-table : incorporated switches

Adaptation front-rear : incorporated switches

IX. Safety

IEC950

X. Environment

The projector is designed to be used within the following operating range.

Max. operating range

Temperature : 0° - 40°C

Humidity : 0 - 90% non condensing

Altitude : 0 - 3000 m (0 - 10000 ft)

Storage

Temperature : -30° to 65°C

XI. Weight

60 kg (133 lbs)

SPECIFICATIONS

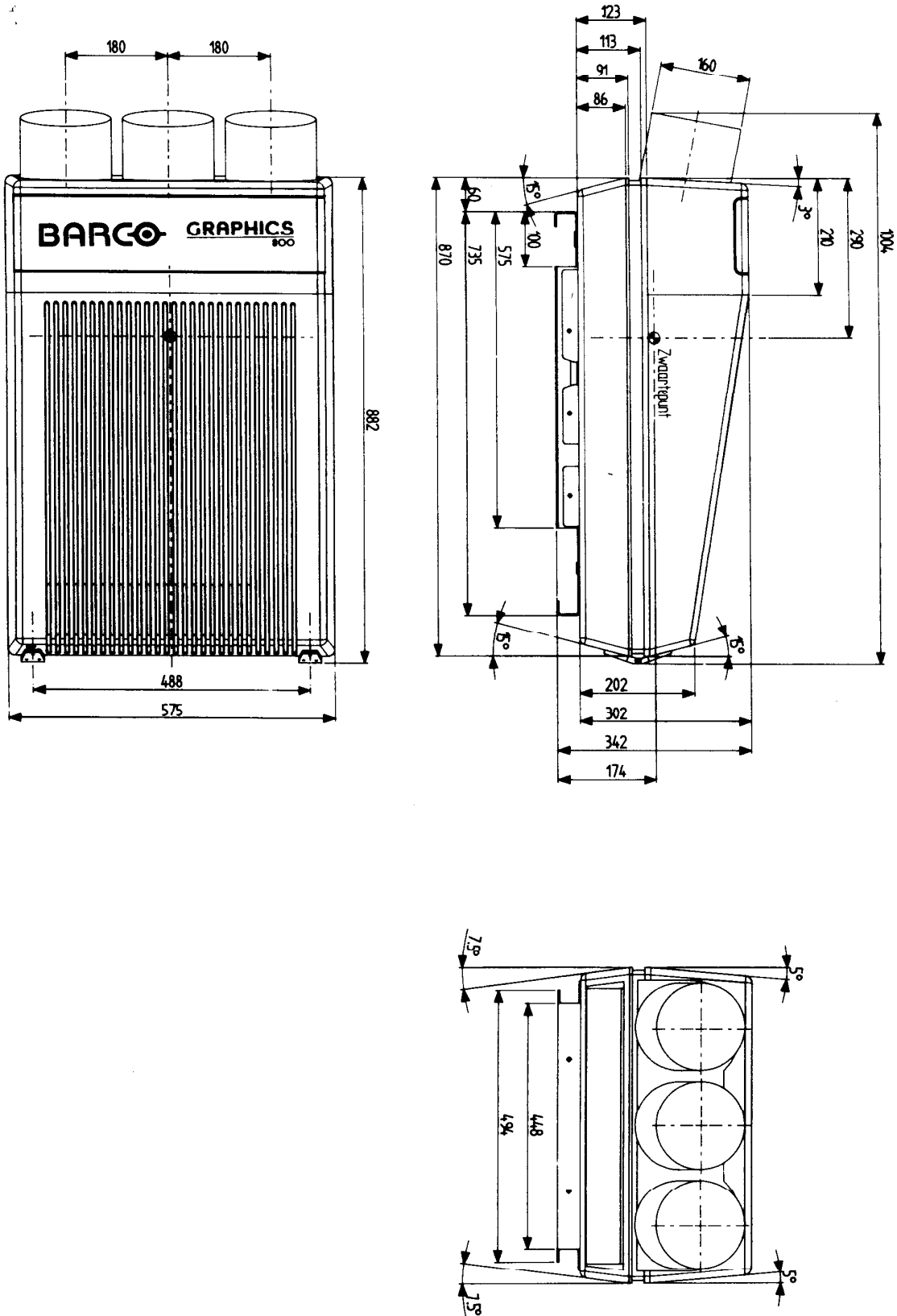

OPTIONS

OPTIONS

RCU800U

IR RECEIVER

REMOTE CABLE RCU800

CONTROL 800 SOFTWARE FOR DOS AND FOR MAC[®]

OPTIONS

RCU800U

Executive Remote Control.

Fixed address setting on 'zero address'. Every projector can be controlled with this RCU800U.

No access possible to the 'Adjustment Mode'.

Order number : 98 27440

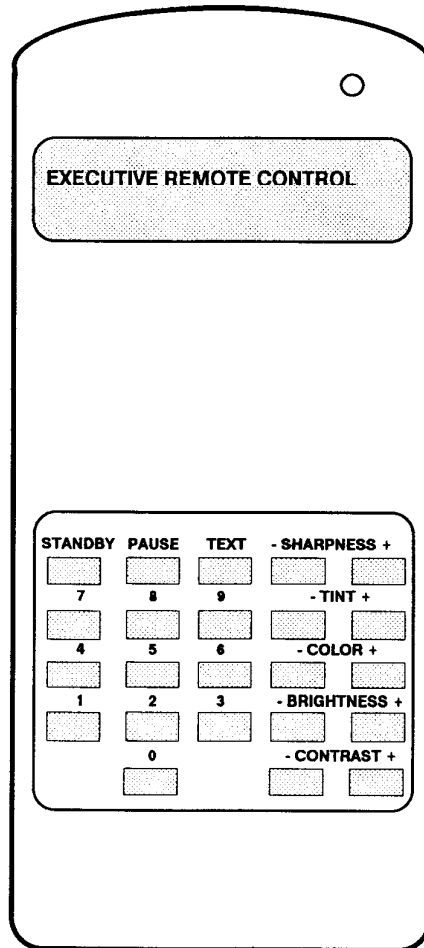

OPTIONS

IR Receiver

This infra red receiver unit makes it possible to control the BARCOGRAPHICS 800 from an other room.

There is a communication line with cable between the IR receiver and the projector or the RCVDS800. The control information from the RCU800 can now be sent to this IR receiver.

The IR receiver displays the selected source on a 7-segment display.

Order number : 98 27510

IR REMOTE RECEIVER 98 27510

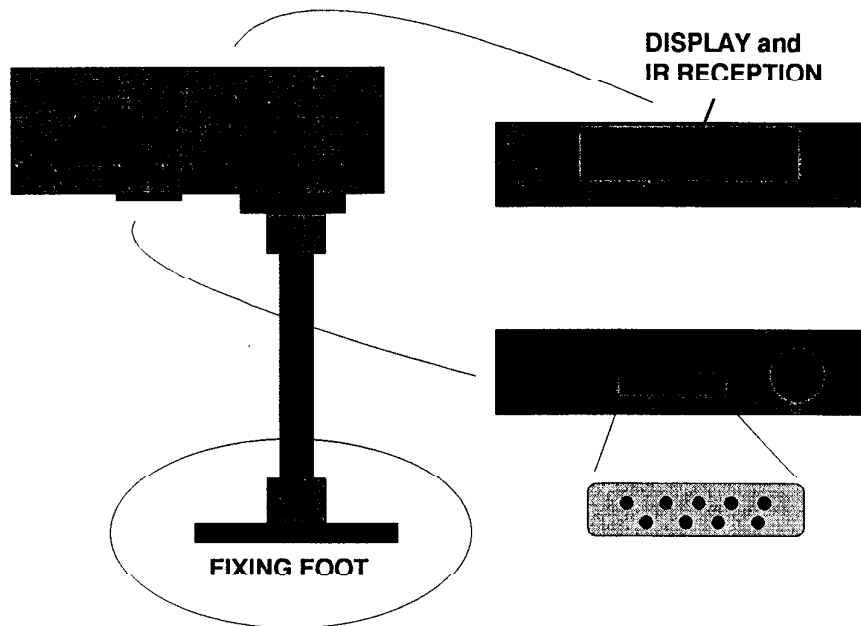

OPTIONS

Hardwired RCU800 or RCU800U.

The control signals from the RCU800 or RCU800U can be sent to the projector via a wired connection.

Preparing your remote cable :

Use a shielded cable with a maximum length of 100 m and two mini-jack 2.5 mm connectors (order number : 31 3043).

- Peel back the vinyl covering of the cable on both sides and twist the wire core.

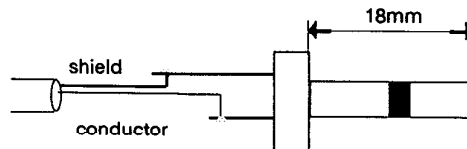

- Solder on both sides of the cable a jack plug as shown in drawing above.
shield = ground
conductor = data information

When the cable is ready, plug one side in the remote control and the other site in the connector on the front of the projector labelled 'remote'.

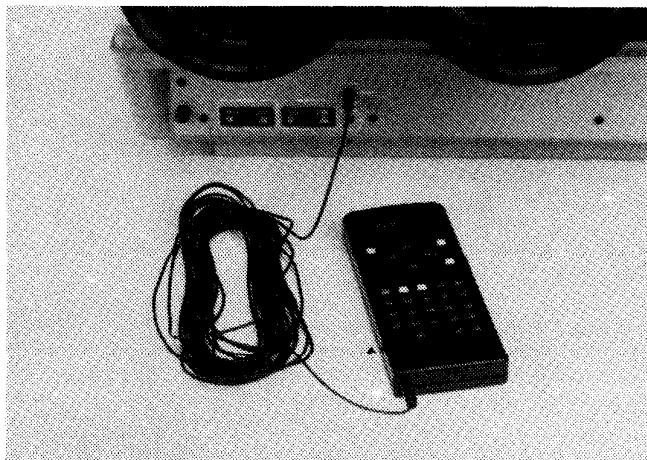

OPTIONS

Control 800 software for DOS and for MAC [®]

The software is user friendly designed : mouse control, pull down menus, dialog boxes.

Two main applications are available with this software : remote control and transferring and receiving data of settings.

remote control simulation. Advantage : address range 0 to 255.

adjustment data : where can it be located when a IBM PC (or compatible) or MAC is connected :

- hard memory device with files of settings.
- the contents of the local memory of the computer.
- the contents of the projector.

Order number DOS version : 98 27530

Order number MAC version : 98 27540

OPTIONS

D9-D9 communication cable

The D9-D9 communication cable is used to form a data communication link between the BARCO 800 series projectors and the RCVDS800, the IR remote receiver 800 or a controlling computer.

Order number for 15 m cable : 98 27560

Order number for 30 m cable : 98 27570

MESSAGES, WARNINGS AND FAILURES

MESSAGES, WARNINGS AND FAILURES.

MESSAGES, WARNINGS AND FAILURES

SOURCE 01
Fh= 15.6 kHz
Fv= 050 Hz

When selecting a new source, information about this source will be displayed on the screen. Source number, horizontal and vertical frequency of the displayed source.

SOURCE 01

Announcement of the selected source.

enter
password
x x x x

Message to enter your password. Password contains 4 digits, which must be entered with the numeric keys of the RCU800.

text on

These messages will be displayed on the screen when pushing the TEXT key.

Text ON : the '*bar scale indication*' will be enabled during the change of an analog control in the '*operational mode*' + all warnings and errors will be displayed.

Text OFF : the '*bar scale indication*' will be disabled during the change of an analog control in the '*operational mode*' + all warnings and errors will not be displayed.

text off

PROJECTOR
ADDRESS :
003

Indication of the projector address when activating 'ADDRESS' on the RCU800 with pencil or other small object.

WARNING :
input not
available

Warning in combination with the RCVDS 800. This warning will be displayed when selecting an input slot of an RCVDS where the input board is missing.

WARNING :
source not
available

The input is a valid input but the source is not connected to the input terminals or the input source is switched off.

MESSAGES, WARNINGS AND FAILURES

WARNING :

**invalid
key entry**

When a wrong key is pressed on the RCU800.

WARNING :

**invalid
code entry**

Message when the entered password is wrong.

WARNING :

**end of ad-
just range**

End of adjustment range.

WARNING :

**input no
longer
available**

Message will be displayed when the input source is no longer available. Immediate hereafter appears the following message : *'check input signal or select new source'*.

**check in-
out signal
or select
new source**

Message will be displayed after the message *'input no longer available'*. It asks to check the connections between the source and the projector or to check if the source is switch on.

WARNING :

**input se-
lector not
available**

It warns you to check the power connection or the power status of the RCVDS800.

Next message will appear immediatly on the screen : *'go to stand-by'*.

WARNING :

**go to
stand by**

Projector will switch to *'stand-by'* when the RCVDS 800 is not longer available.

WARNING :

**invalid
frequency
input**

Entered frequency or frequency of source is out of the projector's range.

MESSAGES, WARNINGS AND FAILURES

WARNING :
default
settings
loaded in
the E2PROM

Adjustment settings are lost. Reset via PC or MAC, or readjust image.

table is
deleted

Message to inform that selected table is deleted. This message will be followed by '*confirm message*', on which the user has to answer.

<ENTER>
to confirm
<EXIT>
to return

Confirm message for deleting tables. ENTER will delete the table. EXIT will return to the selected table.

FAILURE
invalid
RWI soft
version

Wrong software version in your projector. Call for technical support.

FAILURE
invalid
TAC soft
version

Wrong software version in your projector. Call for technical support.

FAILURE
I2C error
addr. : 7FH3

Hardware failure. Call a qualified service technician for repair.

FAILURE
short
circuit on
I2C bus

Hardware failure. Call a qualified service technician for repair.

FAILURE
RCVDS com-
munication
error

Serial communication error between RCVDS800 and projector.

MESSAGES, WARNINGS AND FAILURES

**FAILURE
TAC commu-
nication
error**

Hardware failure. Call a qualified service technician.

**FAILURE
RWI commu-
nication
error**

Hardware failure. Call a qualified service technician.

MESSAGES, WARNINGS AND FAILURES

APPENDIX A : BATTERY REPLACEMENT IN THE RCU

Battery replacement in the RCU800 or the RCU800U.

Remove the battery cover on the backside of the remote control by pushing it backwards.

Remove the battery from the compartment and disconnect the contact plate.

Connect a new 9V battery (type 6F22S or equivalent) to the contact plate.

Insert the battery back into the compartment and put the cover back.

Attention : when a new battery is installed, the projector address must be reprogrammed before using the RCU800. Nothing has to be done for the RCU800U.

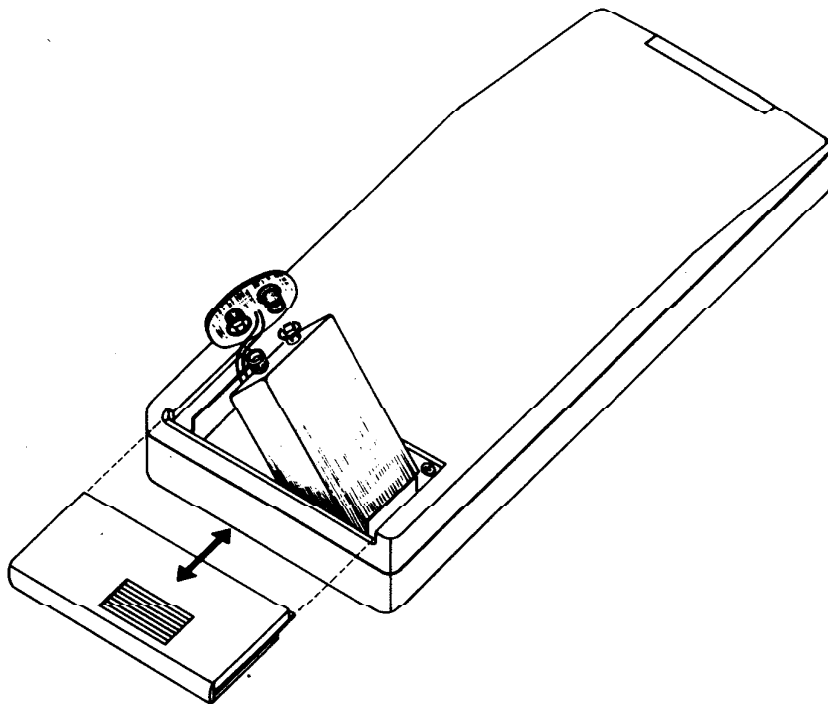

APPENDIX B : ADJUSTMENT BLOCKS

Adjustment Tables

As the Barcographics 800 is digitally controlled, all geometry and convergence adjustments are stored in the projector's memory as numeric values. These numeric values are used to control digital potentiometers which in turn, control the projector. Each source connected to the projector has a unique set of adjustment data which is automatically downloaded into the projector's digital potentiometers as the source is selected. This set of adjustment data is referred to as an "adjustment block".

An adjustment block is automatically created for a source when the source is first connected to the projector and the adjust mode is entered. If other sources have already been connected to the projector and geometry and convergence adjustments have been performed on these sources, the projector will use Linear Digital Interpolation to create a new table for the new source. This block will provide an initial set of adjustments for the new source that have been calculated by the projector from "previous experience".

The projector's memory has the capacity to store 38 adjustment blocks. The adjustment block consists of two parts, the block header and the data representing the convergence and geometry adjustments of the source the block corresponds to. The block header contains the basic characteristics of the source and the projector configuration used to display the source.

<i>Block Header</i>	<i>example of block header</i>
Block number	01
Source number	01
Horizontal frequency	15.6 kHz
Vertical frequency	50 Hz
Input type	video
Scan inversion switch configuration	front/ceiling

The data representing the geometry and convergence adjustments for the source follows the block header.

APPENDIX C : SOURCE NUMBERS 90 - 99

Source numbers 90 - 99

Source numbers 90 - 99 do not correspond to physical inputs to the projector or RCVDS800. They are used to assign an additional adjustment table to a source. This additional adjustment table may contain different geometry and convergence settings, sync fast/slow positions and enhanced blue on/off settings. The relationship between source numbers 0 - 9 and 90 - 99 (projector with RCVDS) or 1 - 5 and 91 - 95 (stand-alone projector) is shown in the diagram below.

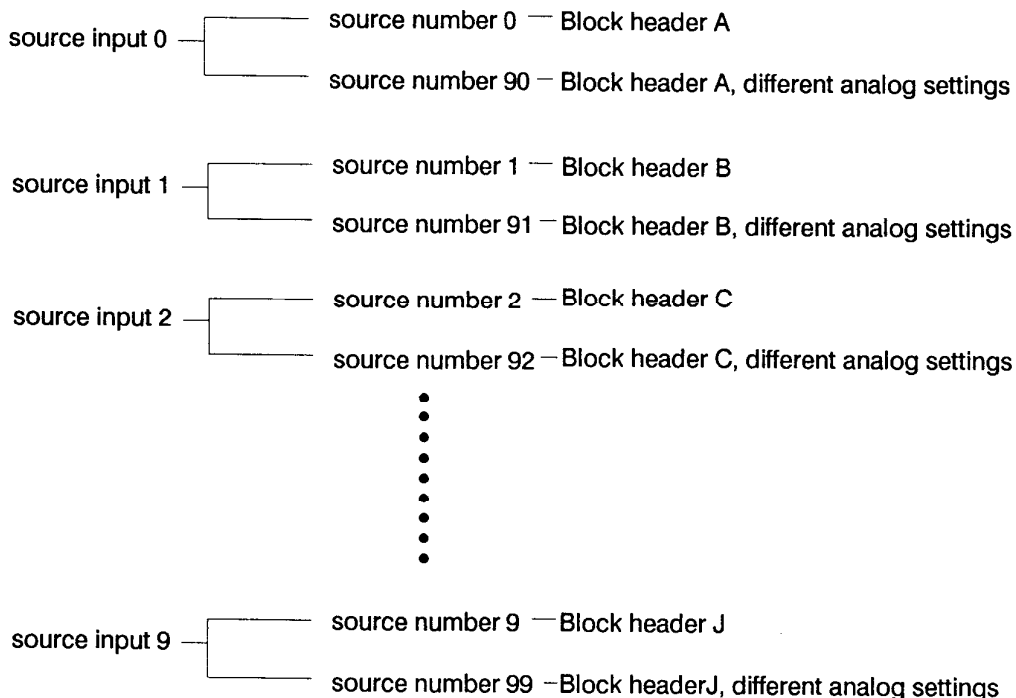

The alternate adjustment block for sources 0 - 9 (projector with RCVDS) or 1 - 5 (stand-alone projector) is activated by selecting the corresponding source number 0 - 9 (projector with RCVDS) or 1 - 5 (stand-alone projector). Once this source number is selected, the alternate block of adjustment data is in use and may be modified via the adjust mode of the projector. The alternate adjustment block is automatically stored.

Follow the steps below to create a second adjustment block for a source between 0 and 9.

1. Select the source between 0 and 9 that the second adjustment block is to be created for.
2. Select the corresponding source number between 90 and 99. The adjustment block for the source number between 0 and 9 is copied to the corresponding source number between 90 and 99.
3. Enter the adjust mode and make any desired changes (geometry, convergence, sync fast/slow, enhanced blue on/off) to the second adjustment block.
4. Exit the adjust mode.

Note : the above also applies to source number 1 - 5 and 91 - 95 of a stand alone projector (no RCVDS)

MATERIAL SAFETY DATA SHEET

Form Approved
Bureau Budget No. 45-R0338
EMERGENCY PHONE NO. 32-56-38211

MANUFACTURER'S NAME AND FSCM (Federal Supply Code for Manufacturer's)
BARCO INC.
ADDRESS (Number, Street, City, State, and ZIP Code)
Noordlaan 5 B- 8720 KUIRNE

CHEMICAL NAME AND SYNONYMS
Polyacetois
Ethylglycol & glycerol
TRADE NAME AND SYNONYMS
Cooling liquid 512334

CHEMICAL FAMILY
FORMULA
C₂H₆O₂ + C₃H₈O₃

FEDERAL STOCK NUMBER (FSN)
GROSS WEIGHT (LBS)
OUTSIDE PACKAGE DIMENSIONS

MIL-STD-1341/NATIONAL FIRE PROTECTION ASSOCIATION STD 704M SIGNAL
FLAMMABILITY
HEALTH
REACTIVITY
SPECIFIC HAZARD

PAINTS, PRESERVATIVES, AND SOLVENTS	%	TRESHOLD LIMIT VALUE (Units)	TRESHOLD LIMIT VALUE (Units)	%
		ALLOYS AND METALLIC COATINGS		
PIGMENTS	/			/
CATALYST	/			/
VEHICLE	/			/
SOVENTS	/			/
ADDITIVES	/			/
OTHERS	/			/

HAZARDOUS MIXTURES OF OTHER LIQUIDS, SOLIDS, OR GASES
TRESHOLD LIMIT VALUE (Units)

SECTION III - PHYSICAL DATA

BOILING POINTS (°C)	20 °C	SPECIFIC GRAVITY (H ₂ O=1)	1.15
VAPOR PRESSURE (mm Hg.)	3 mm Hg	PERCENT VOLATILE BY VOLUME (%)	/
VAPOR DENSITY (AIR = 1)	2.2	EVAPORATION RATE (..... = 1)	/
SOLUBILITY IN WATER	∞	APPEARANCE AND ODOR	

SECTION IV - FIRE AND EXPLOSION HAZARD DATA

FLASH POINT (Method used)	FLAMMABLE LIMITS	LOWER EXPLOSIVE LIMIT	UPPER EXPLOSIVE LIMIT

EXTINGUISHING MEDIA

SPECIAL FIRE FIGHTING PROCEDURES

UNUSUAL FIRE AND EXPLOSION HAZARDS

SECTION V - HEALTH HAZARD DATA

TRESHOLD LIMIT VALUE 100ppm

EFFECTS OF OVEREXPOSURE

EMERGENCY AND FIRST AID PROCEDURES

SECTION VI - REACTIVITY DATA

STABILITY	UNSTABLE	CONDITIONS TO AVOID	
		STABLE	X
			X

INCOMPATIBILITY (Materials to avoid)

HAZARDOUS DECOMPOSITION PRODUCTS

HAZARDOUS POLYMERIZATION	MAY OCCUR	WILL NOT OCCUR	CONDITIONS TO AVOID	
			X	
			X	

STEPS TO BE TAKEN IN CASE MATERIAL IS RELEASED OR SPILLED

SECTION VII - SPILL OR LEAK PROCEDURES

Rinse with water

WASTE DISPOSAL METHOD

SECTION VIII - SPECIAL PROTECTION INFORMATION

RESPIRATORY PROTECTION (Specific type)

VENTILATION	SPECIAL	
	LOCAL EXHAUST	OTHER

PROTECTIVE GLOVES

OTHER PROTECTIVE EQUIPMENT

SECTION IX - SPECIAL PRECAUTIONS

PRECAUTIONS TO BE TAKEN IN HANDLING AND STORING

Harmful if swallowed

Keep out of the reach of children

OTHER PRECAUTIONS

To avoid from oxidants

THE INFORMATION CONTAINED HEREIN IS BASED ON DATA CONSIDERED ACCURATE. IN NO EVENT SHALL THE MANUFACTURER BE RESPONSIBLE FOR ANY DAMAGE OR INJURY TO PERSONS OR PROPERTY CAUSED BY THE MATERIAL IF REASONABLE SAFETY PROCEDURES ARE NOT USED. ADDITIONALLY, VENDOR ASSUMES RESPONSIBILITY FOR INJURY TO PERSONS OR PROPERTY CAUSED BY UNREASONABLE USE OF THE MATERIAL. (SEE SAFETY PROCEDURES ARE ILLUSTRATED ON THE REVERSE SIDE OF THIS SHEET.)